

This article was downloaded by:

On: 27 January 2011

Access details: *Access Details: Free Access*

Publisher *Taylor & Francis*

Informa Ltd Registered in England and Wales Registered Number: 1072954 Registered office: Mortimer House, 37-41 Mortimer Street, London W1T 3JH, UK



Organic Preparations and Procedures International

Publication details, including instructions for authors and subscription information:

<http://www.informaworld.com/smpp/title~content=t902189982>

RECENT PROGRESS IN THE SYNTHESIS, PROPERTIES AND REACTIONS OF TRISULFANES AND THEIR OXIDES

Edward L. Clennan^a; Kristina L. Stensaas^a

^a Department of Chemistry, University of Wyoming, Laramie, WY, USA

To cite this Article Clennan, Edward L. and Stensaas, Kristina L.(1998) 'RECENT PROGRESS IN THE SYNTHESIS, PROPERTIES AND REACTIONS OF TRISULFANES AND THEIR OXIDES', *Organic Preparations and Procedures International*, 30: 5, 551 – 600

To link to this Article: DOI: 10.1080/00304949809355321

URL: <http://dx.doi.org/10.1080/00304949809355321>

PLEASE SCROLL DOWN FOR ARTICLE

Full terms and conditions of use: <http://www.informaworld.com/terms-and-conditions-of-access.pdf>

This article may be used for research, teaching and private study purposes. Any substantial or systematic reproduction, re-distribution, re-selling, loan or sub-licensing, systematic supply or distribution in any form to anyone is expressly forbidden.

The publisher does not give any warranty express or implied or make any representation that the contents will be complete or accurate or up to date. The accuracy of any instructions, formulae and drug doses should be independently verified with primary sources. The publisher shall not be liable for any loss, actions, claims, proceedings, demand or costs or damages whatsoever or howsoever caused arising directly or indirectly in connection with or arising out of the use of this material.

**RECENT PROGRESS IN THE SYNTHESIS, PROPERTIES
AND REACTIONS OF TRISULFANES AND THEIR OXIDES**

Edward L. Clennan* and Kristina L. Stensaas

*Department of Chemistry, University of Wyoming
Laramie, WY 82071-3838, USA*

INTRODUCTION	553
I. STRUCTURE AND PHYSICAL PROPERTIES OF TRISULFANES AND THEIR OXIDES	554
II. SYNTHESIS OF TRISULFANES	561
1. <i>Formation of S-S Bonds</i>	561
2. <i>Formation of S-C Bonds</i>	569
III. REACTIONS OF TRISULFANES	576
1. <i>Thermolysis</i>	576
a. Disproportionations and Exchanges	576
b. Sulfur Expulsions	577
c. Rearrangements	578
d. Pyrolysis	579
2. <i>Nucleophilic Cleavage</i>	580
3. <i>Oxidation</i>	584
a. Trisulfane-monooxides 107 and 108	585
b. Trisulfane-dioxides 109-112	589
c. Trisulfane-tri- and tetraoxides (113-120)	591
REFERENCES	593

RECENT PROGRESS IN THE SYNTHESIS, PROPERTIES AND REACTIONS OF TRISULFANES AND THEIR OXIDES

Edward L. Clennan* and Kristina L. Stensaas

Department of Chemistry, University of Wyoming
Laramie, WY 82071-3838, USA

INTRODUCTION

Trisulfanes, also known as trisulfides, are compounds which contain three consecutive divalent (sulfenyl) sulfur atoms. (i. e. XSSSX) They are members of a homologous series of sulfanes (XS_nX) which are integrally related by disproportionations.¹ (Eq. 1) These disproportionations often occur at or near room temperature and contribute to the difficulty of isolation and purification of polysulfanes.²



The chemistry of the two lower homologues, sulfanes (sulfides) and disulfanes (disulfides), has dominated the literature. However, interest in the trisulfane linkage has increased rapidly in the past few years as a result of the isolation and structural assignment of the fermentation-derived anti-tumor antibiotic calicheamicin γ_1 (**1**).^{3,4} The trisulfane linkage in **1** acts as the trigger for a Bergman Cyclization of the enediyne unit to give a 1,4-diyne that when bound in the minor groove of DNA abstracts hydrogen atoms, resulting in single- and double-stranded scissions.

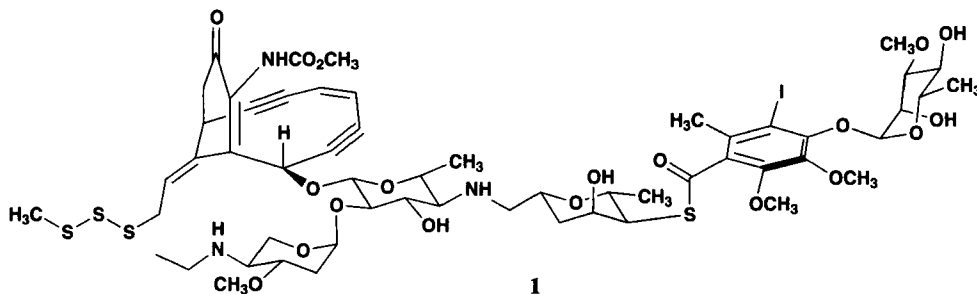

Naturally occurring trisulfanes have been known for a considerable amount of time and are often found to exhibit biological activity. Garlic (*Allium sativum* L.) for example is a rich source of organosulfur compounds including trisulfanes. Two of these garlic derived trisulfanes, methyl 2-propenyl trisulfane and bis(2-propenyl) trisulfane are known to inhibit aggregation of blood platelets.⁵

Numerous trisulfanes have been isolated and continue to be isolated from marine organisms.⁶ Lenthionine, (2), (1,2,3,5,6-pentathiepane) was isolated from the red alga *Chondria californica*,⁷ bis-(3-oxoundecyl)trisulfane, (3),⁸ was isolated from the Hawaiian algae *Dictyopteris plagiogramma* and *D. australis*, and 5-methylthio-1,2,3-trithiane, (4), was isolated from the freshwater green alga *Chara globakiris*.^{9, 10} The novel 1,2,3-trithiane derivative, (5), was isolated from the New Zealand Ascidian *Aplidium* SP. D,¹¹ and Lissoclinotoxin A, (6), was isolated from the tunicate *Lissoclinum Perforatum*.¹²

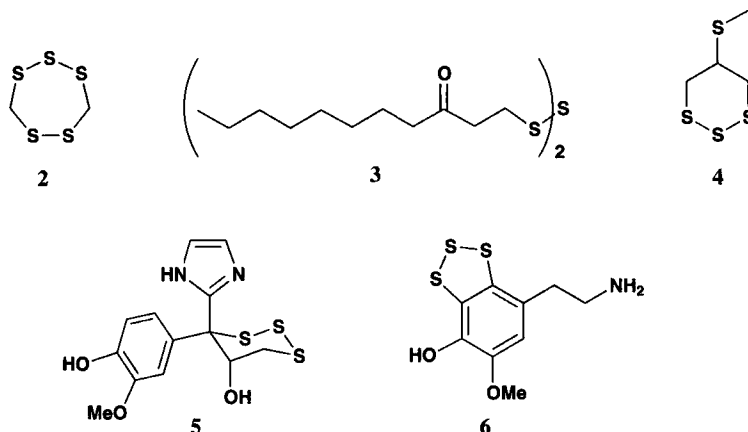

Recently a trisulfane counterpart of the biosynthetic human growth hormone has been detected, and thiocystine and a mixed trisulfane of glutathione have been isolated, by a mild extraction procedure from the organism *Rhodospseudomonas spheroides*.¹³ These results have led to the speculation that trisulfane cystine linkages exist *in vivo*. The possibility that these trisulfane peptides might exhibit the same biological activity as their disulfane counterparts has not been extensively investigated. However, preliminary results with several glutathione-like trisulfanes demonstrate that they can be reduced by disulfane reductases and that Vasopressin trisulfane, (7), and Vasopressin disulfane exhibit identical affinity for V₁ type receptors found in smooth muscle cells, in hepatocytes, and in platelets.¹⁴

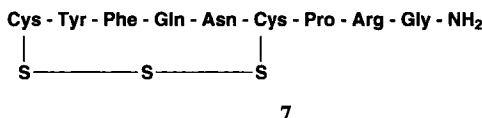

In this review we will concentrate on the structure, properties, synthesis, and reactivity of organic trisulfanes and their oxidized derivatives. Earlier reviews by Schöberl and Wagner,¹⁵ Wilson and Buchanan,¹⁶ Field,¹⁷ Gundermann and Hümke,¹⁸ and Steudel and Kustos,¹⁹ examined the synthesis of trisulfanes in the broader context of polysulfane chemistry.

I. STRUCTURE AND PHYSICAL PROPERTIES OF TRISULFANES AND THEIR OXIDES

X-ray structural data for acyclic trisulfanes 8,²⁰ trisulfane-oxides 9-12,²¹ cyclic trisulfanes

13,²² metal complexed derivatives 14,²³ and thiathiothephene and its alkylated derivatives 15,²⁴ have been reported.

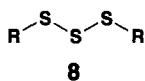

a. R = -C(Cl)₂C(O)tBu

b. R = -C(O)SCH₃

c. R = -(CH₂)₂I

d. R = o-NO₂C₆H₄-

e. R = -C(S)-N(CH₂CH₂)₂O

f. R = -(CH₂)₁₇CH₃

g. R = -C(SiMe₃)₃

h. R = -C(S)OCH₃

i. R = -CCl₃

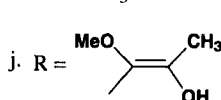

k. R = -CF₃

l. R = -CN

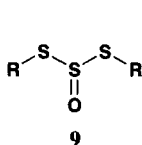
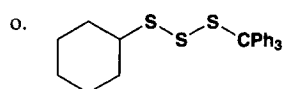
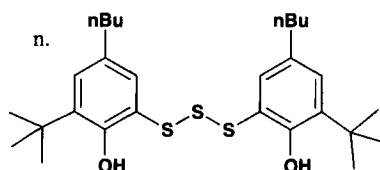
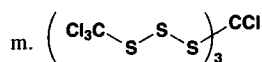

a. R = pClC₆H₄-

b. R = Ph-

c. R = -C(Ph)₃

d. R = -C(CH₃)₃

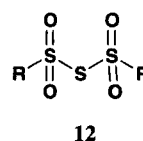
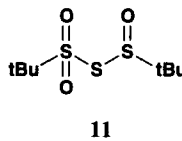
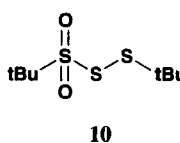
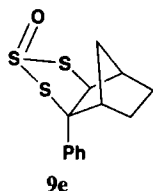

a. R = Ph-

b. R = pMeC₆H₄-

c. R = t-Butyl-

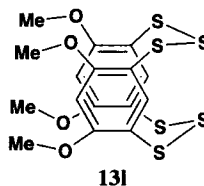
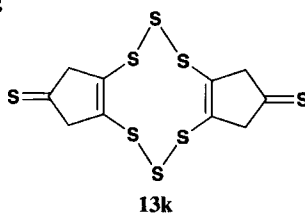
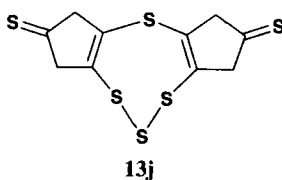
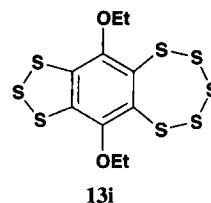
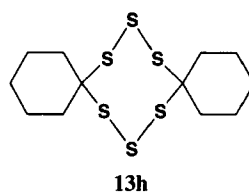
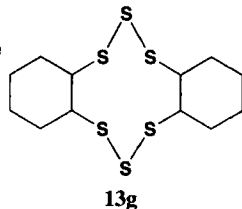
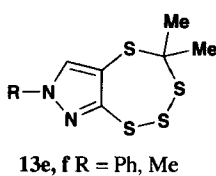
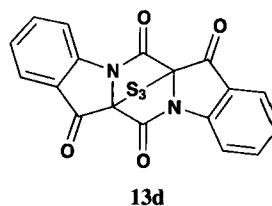
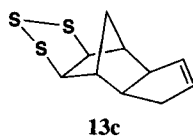
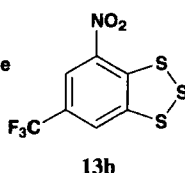
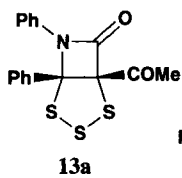

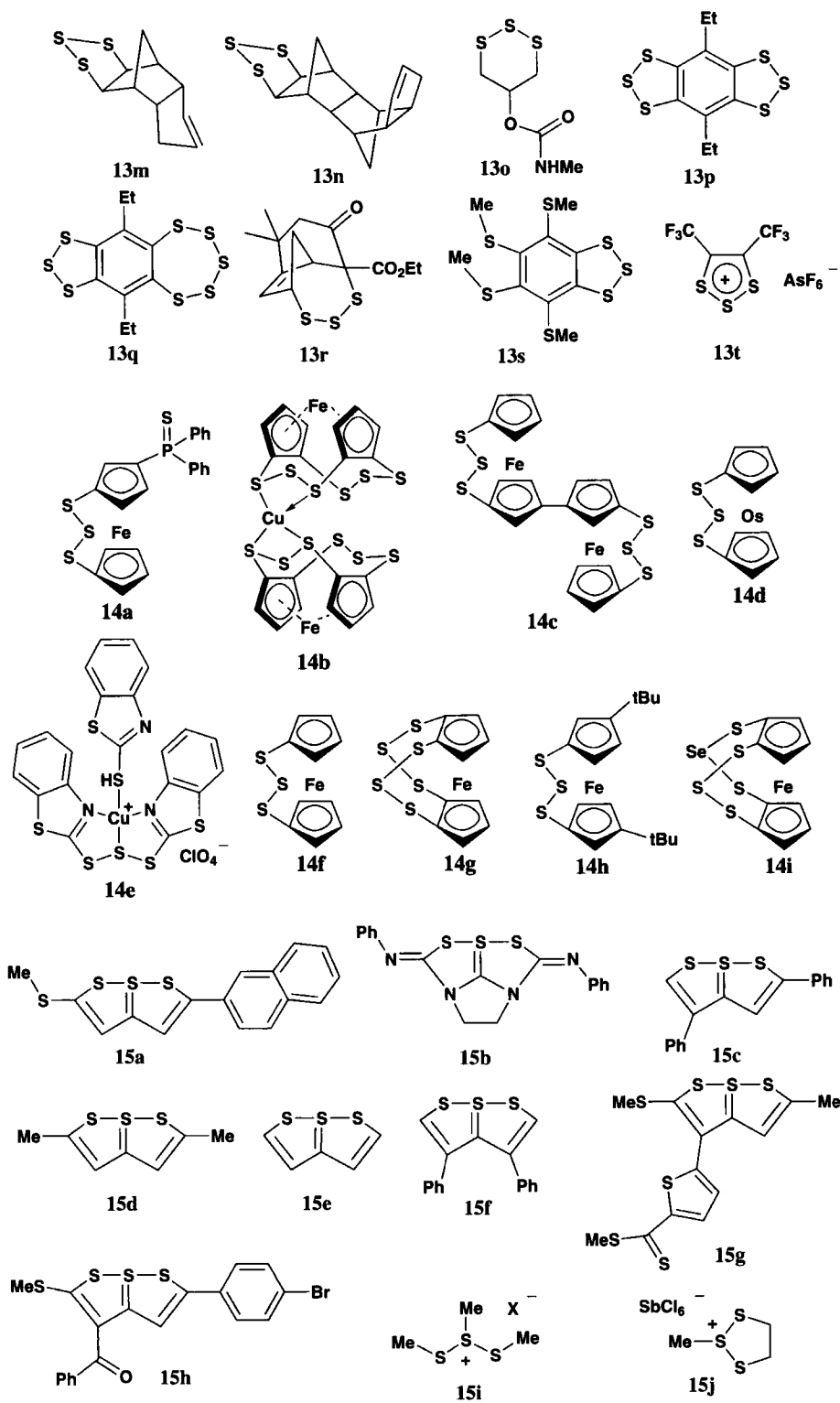

The most important structural parameters for the acyclic trisulfanes, **8**, are given in Table 1. All the trisulfanes, with the exception of **8h** and **8l**, form trans structures with the two substituents on opposite faces of the plane defined by the three sulfur atoms.^{25, 26} The trans disposition of the two substituents can be most easily discerned by examination of the torsional angles, τ_{CSSS} , which are of the same sign, ++ (or -- for its enantiomer). The two trisulfanes which adopt the cis conformation, with torsional angles of opposite signs, exhibit weak interactions with the middle sulfur of a nearby trisulfane. For example, the middle sulfur atom in the xanthate trisulfane, **8h**, is within 3.625(6) and 3.709(8) Å of two sulfur atoms from adjacent molecules.²⁶ For comparison, the sum of the van der Waals radii of two sulfurs is only 3.70 Å. It appears that it is these interactions which sterically dictate adoption of the cis conformation. The absolute values of the torsional angles around the S-S bonds range from 67° to nearly 107°. Significant deviation from 90° appears to be associated with the steric bulk of the substituent on sulfur. The SSS angles are all between 104.2° and 113.2° which are very similar to that found in other polysulfanes. The S-S bond lengths all fall within the somewhat large range of 2.012 to 2.086 Å. The factors influencing the S-S bond lengths are complex and as a consequence no real trend is observable in the data depicted in Table 1.

Table 1. Structural Parameters for Trisulfanes **8**^a

Cmpd	$d_{\text{S-S}}$	$d_{\text{C-S}}$	τ_{CSSS}	>SSS
8a	2.032, 2.028	1.843	-96.1, -92.5	108.01
8b	2.044	1.788	+83.1, +83.1	107.94
8c	2.046	1.857	+80.3, +80.3	113.22
8d	2.054, 2.051	1.787	+87.8, +81.6	106.35
8e	2.012, 2.015	1.799	+92.4, +78.6	108.82
8f	2.023, 2.030	1.802	+72.8, +67.3	106.30
8g	2.066, 2.057	1.859	+104.6, +93.2	112.54
8h	2.043, 2.059	1.741	+102.4, -92.5	104.20
8i	2.032, 2.037	1.772	-92.5, -95.8	105.95
8j	2.086	1.802	-106.8, -106.8	106.82
8k	2.041	1.815		106.70
8l	2.071	1.701	+87, -87	105.34
8m	2.046, 2.030	1.820	-95.3, -91.6	105.75
8n	2.058	1.780	-85.3, -85.3	105.94
8o	2.032, 2.041		+103.7, +89.2	108.47

a. Data collected from the Cambridge Structural Database.²⁷

The cyclic trisulfanes adopt geometries dictated by their cyclic framework. Five-membered ring trisulfanes, **13a**, **13b**, **13c**, **13i**, **13m**, **13n**, **13p**, and **13q** adopt envelope conformations with the middle sulfur atom as the flap. The cyclic thiathiophthenes, **15a-h**, are fascinating molecules which

are formally oxidized derivatives of trisulfanes. In many respects however, they are very different than their 2-oxo-homologues, **9**, their 2-alkylated derivative, **15i**, or the trisulfanes, **8**. (Table 2) For example, the trisulfane linkages in the thiathiophthenes are nearly linear with SSS angles near 180° and have very long S-S bonds. These unusual structural parameters have led to much speculation about whether they can be best described as having double rather than single energy (structural) minima.^{28, 29, 30, 31} (Fig. 1)

Table 2. Structural Parameters for Some Trisulfane Derivatives^a

Cmpd	d_{S-S}	d_{C-S}	τ_{CSSS}	>SSS
15a	2.224, 2.488	1.696	-17.73, 21.62	175.3
15c	2.510, 2.212	1.701	-7.46, 6.26	178.8
15d	2.350	1.694	-5.91, 5.92	177.4
15e	2.350	1.673	-34.61, 34.61	177.9
9a	2.124	1.778	-176.77, -176.77	91.3
9b	2.123, 2.141	1.770	158.43, 162.76	88.3
15i	2.056, 2.041	1.792	90.42, 52.70	108.5

a. Data collected from the Cambridge Structural Database.²⁷

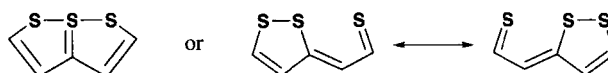

Fig. 1

A conformational analysis study of dihydrogen- and dimethyl-trisulfane was reported by Snyder and Harpp³² using a combination of force field and semiempirical molecular orbital studies. A conformational interconversion diagram for both compounds containing the computed values of the stationary points is given in Fig. 2. In both cases the trans conformer is more stable than the cis conformer although the energy difference, 0.3 kcal/mol in dihydrogen trisulfane and 0.9 kcal/mol in dimethyltrisulfane, is very small. The transition state for interconversion of these two conformers has an exo-half planar geometry, **A**. Other possible structures for the transition state including the endo-half planar species, **B**, and the completely planar exo-exo-, endo-exo-, and endo-endo- species, **C**, **D**, and **E**, were located, but at considerably higher energies than **A**. These results suggest that trisulfanes exist as a mixture of conformers which rapidly interconvert at room temperature. The magnitudes of the interconversion barriers, 7.1 kcal/mol for dihydrogentrisulfane and 7.4 kcal/mol for dimethyltrisulfane, are similar to rotational barriers reported for disulfanes.

In contrast, the barriers for ring reversal in metallocenophanes such as **14a**³³ and **14g**³⁴ are high enough to preclude conformational interconversions at room temperature. 1,1',2,2'-bis(1,2,3-Trithia-[3])ferrocenophane, (**14g**), exists as a 70/30 mixture of the chair-chair and chair-boat conformers. Substitution of one of the middle sulfur atoms in **14g** with a selenium atom leads to the

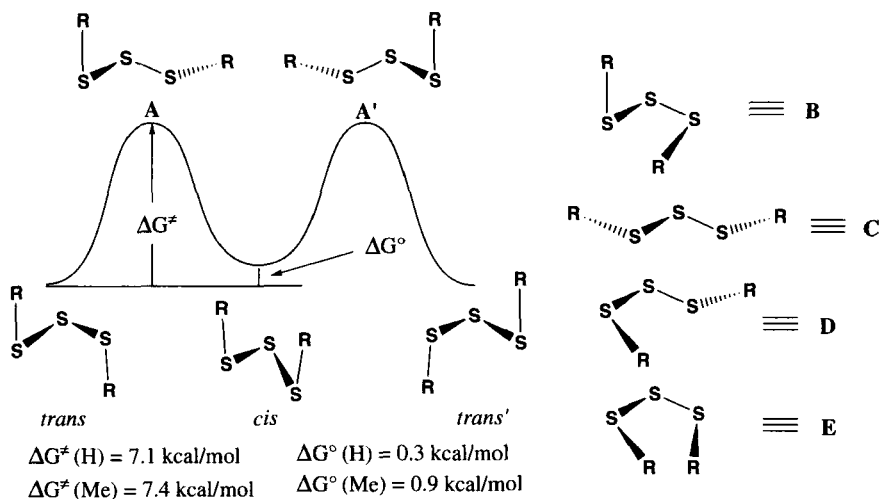
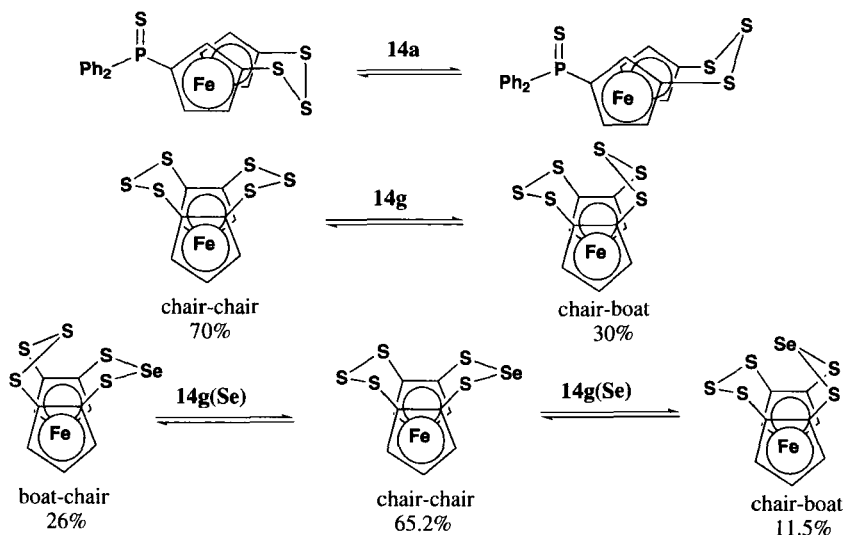

Fig. 2

observation of diastereomeric boat-chair and chair-boat conformers. The boat-chair conformer with the smaller sulfur atom as part of the boat portion of the molecule predominates.



The osmocenophane, **14d**, and its ferrocene and ruthenocene analogues have very different barriers for interconversion as shown in Table 3.³⁵ The magnitudes of the activation barriers mimic the strength of the metal ring bond $\text{Fe} < \text{Ru} < \text{Os}$ suggesting that the coplanar cyclopentadienyl rings are significantly twisted in the transition state for ring inversion. Consequently, it is the necessity to partially cleave the metal cyclopentadienyl bond rather than an unanticipated trisulfane torsional barrier which dictates the magnitudes of the interconversion barriers.

Table 3. Activation Barriers for Ring Inversions in Metallocenophanes

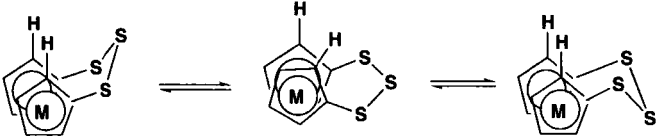

Metal	ΔG^\ddagger , kcal/mol	ΔH^\ddagger , kcal/mol	ΔS^\ddagger , cal/K
Os	22.2 ± 0.3	25.4 ± 0.4	11 ± 5
Ru	21.2 ± 0.1	22.1 ± 0.5	3 ± 1
Fe	19.2 ± 0.05	18.4 ± 0.2	-3 ± 0.5

The structural analyses of trisulfanes have typically been carried out using a combination of high performance liquid chromatography (HPLC), mass spectral analysis, combustion analysis, and ^1H and ^{13}C NMR. Combustion analysis and HPLC¹⁹ in particular are very useful to detect the presence of polysulfane contaminants. The mass spectral fragmentation's of diethyltrisulfane reported by Block and coworkers³⁶ are typical of many trisulfanes. (Fig. 3) Shmakov and coworkers³⁷ examined dimethyl-, ethyl methyl-, and diethyl trisulfanes by negative ion mass spectrometry. The data allowed determination of an S-S bond dissociation energy of 1.9 ± 0.1 eV which is 0.6 eV (14 kcal/mol) smaller than for the corresponding dialkyl disulfanes. The difference in bond dissociation energy of 14 kcal/mol for RSSR and RSSSR is nearly identical to the reported bond dissociation energy difference for ROOR/ROOOR of 15 kcal/mol.³⁷

Proton and carbon NMR data have been used primarily to determine the structures of substituents. Clennan and Stensaas³⁸ however, took advantage of the different ^1H chemical shifts of the methoxy groups in bis-(p-methoxyphenyl)trisulfane and its oxides in order to study the mechanism of its oxidation.

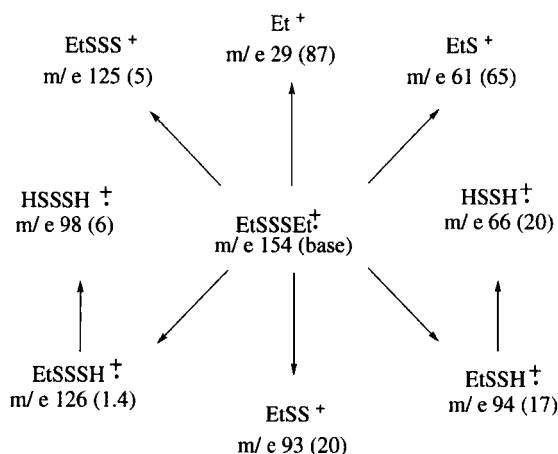
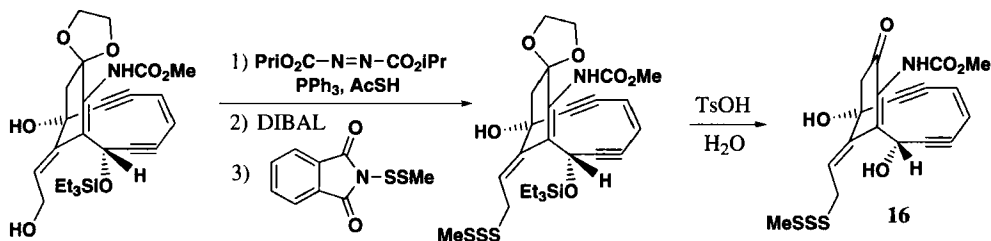

Fig. 3

II. SYNTHESIS OF TRISULFANES

A large number of synthetic methods to construct the trisulfane moiety have been reported. In practice, introduction of the trisulfane functional group should be done near the end of long synthetic sequences as a result of its reactivity towards many nucleophiles as well as oxidizing and reducing agents (*vide infra*). Such a synthetic strategy was employed in the synthesis of (\pm)-Calicheamicinone, (**16**), where only mild acid hydrolysis to remove two protecting groups was used after introduction of the trisulfane group.³⁹



In the following discussion of synthetic methods to construct trisulfanes we will make a distinction between those reactions which involve formation of S-S bonds and those that involve formation of S-C bonds. There are examples (e. g. formation of **17**)⁴⁰ which involve both S-S and S-C bond formations but these are rare.

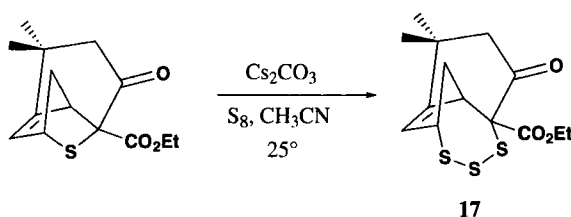

1. Formation of S-S Bonds

Nucleophilic substitutions, oxidations, rearrangements, and electrochemical methods have all been used to construct the S-S bonds in trisulfanes. A simple bond disconnection analysis (Fig. 4) reveals that there are fundamentally two different protocols for the nucleophilic substitution reactions. In protocol A the leaving group, X, is attached to the disulfane moiety, and in protocol B to the sulfane moiety. (In the case of unsymmetrical trisulfanes, R'SSSR, there are of course two additional pathways since the R'-substituent can be in either the one or two sulfur fragment.) Protocol A in particular is very common since it is a critical step in the reactions of SCl_2 with thiols. (Fig. 4) Protocol B is the second step of the reactions of H_2S with sulfonyl chlorides that gives symmetrical trisulfanes. These two protocols along with the wide range of leaving groups that can be utilized ($\text{X} = -\text{NR}_2, \text{Cl}, -\text{SO}_2\text{Ar}, -\text{SO}_3\text{AR}, \text{CH}_3\text{C}(\text{O})\text{S},$ and OR) make S-S bond formation by nucleophilic substitution the most prevalent method of trisulfane formation.

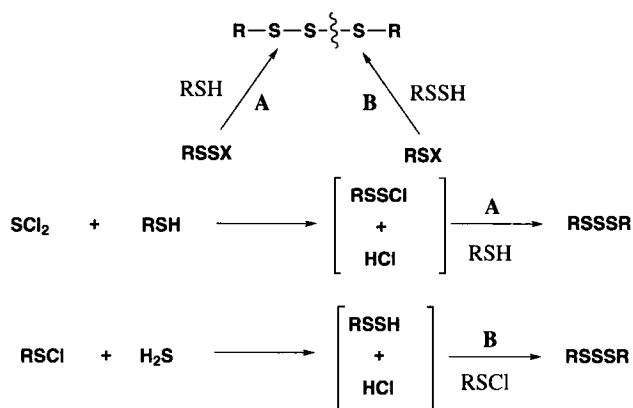
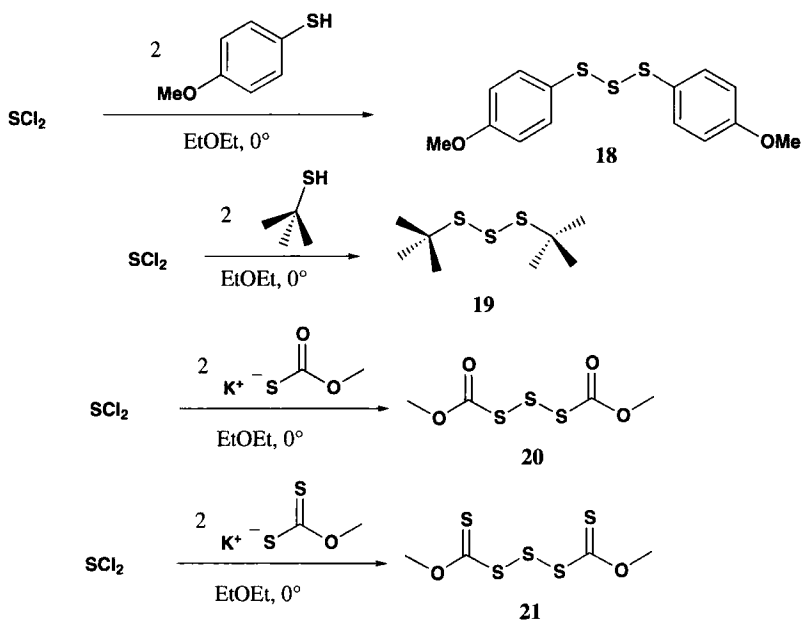

Fig. 4

Sulfur dichloride (SCI_2) is a very convenient synthon for S^{2+} and has been used to make many different types of symmetrical cyclic¹⁰ and acyclic trisulfanes including bis-aryltrisulfanes **18**,³⁸ bis-dialkyltrisulfanes **19**, bis-carbonyltrisulfanes **20**,⁴¹ and bis-thiocarbonyltrisulfanes, **21**. It is commercially available as either a neat liquid or in a 1.0M dichloromethane solution.⁴¹ Most commercial suppliers provide it as a "tech grade" material containing approximately 15-20% sulfur monochloride (S_2Cl_2). The neat "tech grade" material can be purified by fractional distillation followed by a simple distillation in the presence of 0.1% PCl_5 , all at atmospheric pressure.⁴² The pure sulfur dichloride is collected as a red liquid at 59-60°. Sulfur dichloride is a very reactive sulfonylating agent and its reactions with a wide variety of nucleophiles are visibly exothermic. Typical reaction conditions involve slow addition of a nucleophile to diethylether solutions of SCI_2 at 0°.



SYNTHESIS, PROPERTIES AND REACTIONS OF TRISULFANES AND THEIR OXIDES

The versatility of this simple nucleophilic substitution reaction has been extended with the utilization of a wide range of nucleophiles. 1°, 2°, or 3° Thiols, with or without⁴² a tertiary amine to control the pH of the reaction mixture, give moderate to excellent yields of trisulfanes. Titanocene sulfanes have been reported to react with SCl₂ to give cyclic trisulfanes as illustrated by the following two examples.⁴³

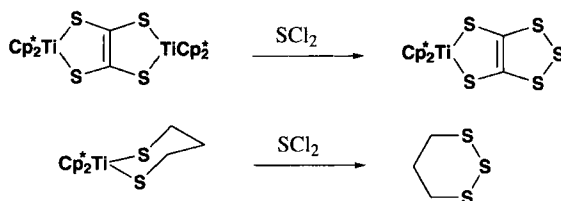

Silyl⁴⁴ and tin sulfanes⁴⁵ also function as nucleophiles in reactions with SCl₂ to give trisulfanes. Recently, this reaction has been adapted to generate cyclic trisulfanes from cyclic and acyclic silyl and tin sulfanes (e. g. **22-25**).⁴⁶ These reactions proceed to give good to moderate yields of the trisulfanes when the SCl₂ is added slowly to THF solutions of the sulfanes at 0°. The cyclic and acyclic silyl or tin sulfane substrates can be conveniently synthesized in excellent yields by treating the thiol with dichloro- or monochloro- organosilanes or stannanes, respectively. Six and seven membered ring trisulfanes are produced in acceptable yields by this method but all attempts to generate the 5-membered ring trithiolane ring system failed, giving preferentially oligomers. The use of these silyl and tin sulfanes, rather than the underivatized thiols, often provide enhanced yields of trisulfanes. For example, the reaction of silyl sulfane **24** with SCl₂ gave a better yield (75%) of trisulfane than the traditional procedure of treating 1,3-propane-dithiol with SCl₂ in the presence of triethylamine (43%).⁴⁶

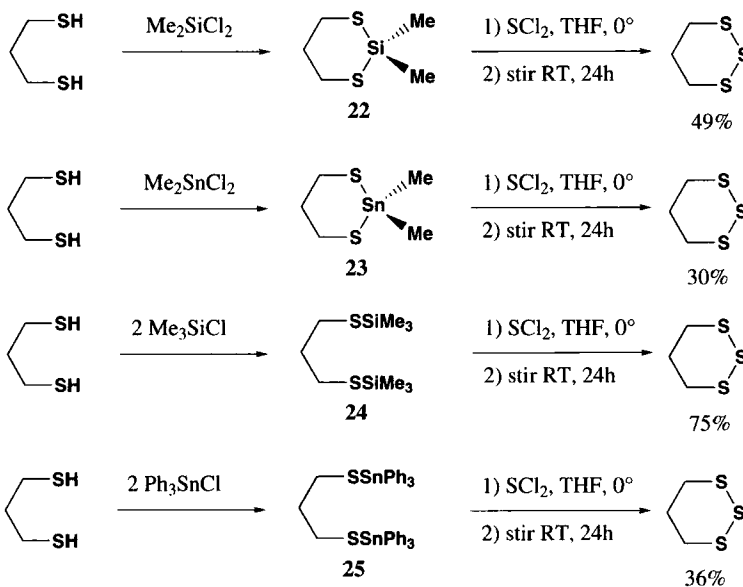

The SCl_2 route to trisulfanes can also be modified to generate excellent yields of unsymmetrical trisulfanes.⁴⁷ This modification involves addition of 1 equivalent of a thiol to a solution of SCl_2 in ether/pyridine or ether/ Et_3N at -78° and subsequent stirring of the cold reaction mixture for approximately 0.5 hours. At this point one equivalent of a second thiol is added and the cold solution stirred for an additional 0.5 hours. Workup involves warming to room temperature followed by removal of solvent. This procedure results in excellent yields of several unsymmetrical trisulfanes including *tert*-butyl *iso*-propyltrisulfane (96%), benzyl *tert*-butyltrisulfane (75%), and moderate yields of other trisulfanes including *p*-chlorobenzyl *tert*-butyltrisulfane (57%) and benzyl *n*-butyltrisulfane (25%). It was suggested that these reactions proceed *via* intermediate formations of chlorodisulfanes, **26**.⁴⁷ In fact, *tert*-butyl chlorodisulfane proved to be stable enough to isolate at room temperature which experimentally substantiates this claim.⁴⁷

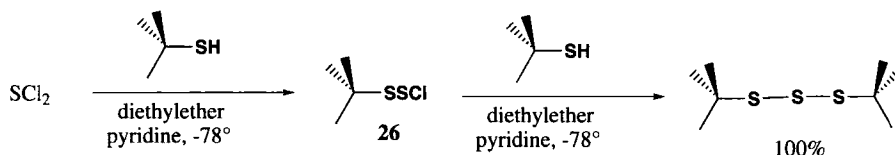

Sulfur dichloride does have several disadvantages related to its use. First of all, byproducts are occasionally observed. For example, addition of SCl_2 to the bis-thiolate, **27**, resulted in formation of both a trisulfane and a pentasulfane in comparable yields.⁴⁸ Furthermore reactions of alkyl-bis-thiols, **28**, with SCl_2 or sodium tetrasulfane have been reported to generate trisulfanes contaminated with disulfanes.⁴⁹

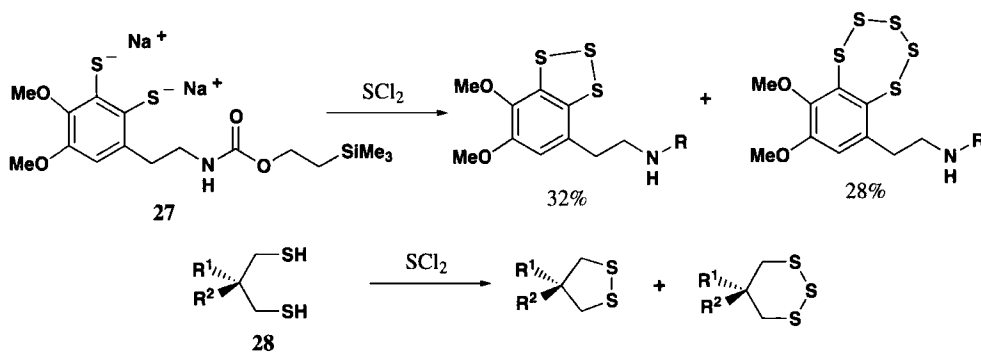

A second disadvantage of sulfur dichloride is related to the fact that its shelf life is limited as a result of its tendency to produce elemental sulfur, chlorine, and a series of homologous sulfur dichlorides, S_xCl_2 .^{50, 51} As a result, multiple distillations (*vide supra*) are required for purification prior to every procedure. Attempts to circumvent this problem have led to various studies designed to generate alternative S^{2+} synthons to replace SCl_2 .

N,N'-Thiobisphthalimide, **29**, was introduced by several groups^{52, 53} as a sulfur transfer agent and was shown to react with thiols to give trisulfanes.⁵² Unfortunately, the increased stability of **29**

compared to SCl_2 is accompanied by reduced reactivity. Attempts to use **29** to generate cyclic trisulfanes by sulfur transfer to bis-thiols were unsuccessful.⁵¹

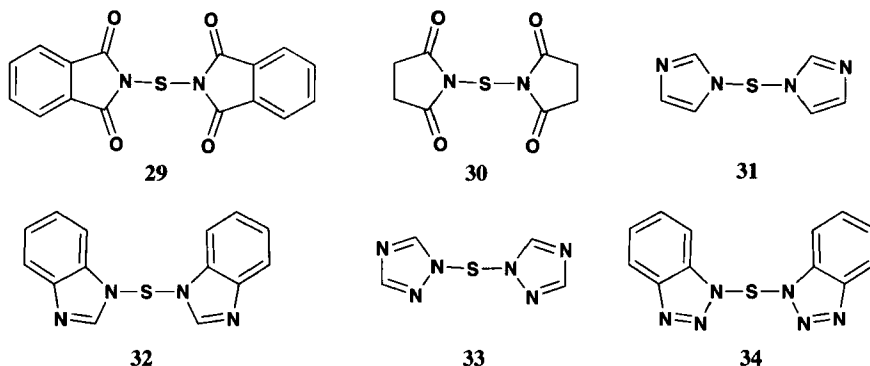

Harp and coworkers⁵¹ compared the sulfur transfer ability of **29** to that of N,N'-thiobis succinimide, (**30**), N,N'-thiobisimidazole, (**31**), N,N'-thiobisbenzimidazole, (**32**), N,N'-thiobis-1,2,4-triazole, (**33**), and N,N'-thiobis-1,2,3-benzotriazole, (**34**). These sulfur transfer agents were conveniently synthesized by reaction of the nitrogen heterocycle with hexamethyldisilazane followed by 0.5 equivalents of SCl_2 . All these reagents reacted with 2 equivalents of benzyl mercaptan and other thiols⁵⁴ to give the corresponding trisulfanes. The yields of bis-benzyltrisulfane using the azole and triazole reagents **31-34**, (92-100%), however, were far superior to those observed with the imide reagents **29** (27%) or **30** (84%). A qualitative analysis of their reactivity suggests the following order **31** > **33** > **32** > **34** > **30** > **29**. The authors⁵¹ suggested that the first step of these reactions is not a nucleophilic attack at sulfur but protonation of the sulfur transfer agent. (Fig. 5)

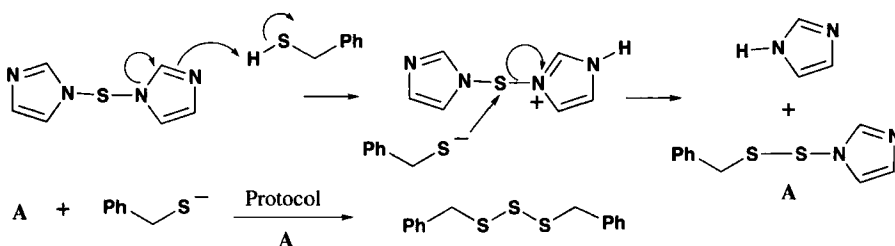
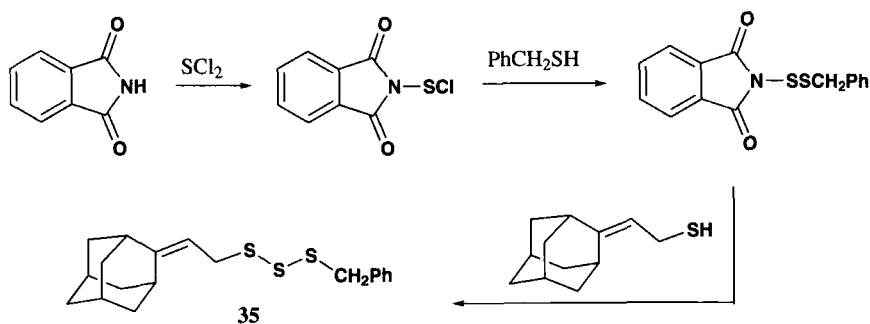
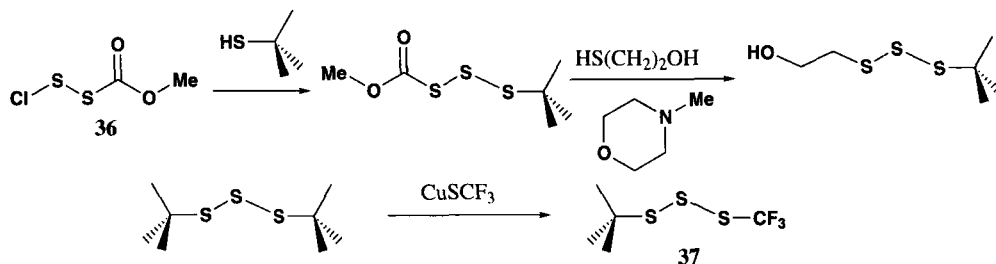

Fig. 5

The conversion of the disulfane intermediate A (Fig. 5) to bisbenzyltrisulfane is an example of protocol A, (Fig. 4) where the protonated imidazole is the leaving group and a thiol (benzyl mercaptan) is the nucleophile. Phthalimide disulfanes, the presumed intermediates in the reactions of **29**, can be independently synthesized, isolated, purified, and used to make unsymmetrical trisulfanes⁵⁵ (e. g. **35**).⁵⁶



In 1984 Mott and Barany⁵⁷ reported a new method for the synthesis of unsymmetrical trisulfanes which involved an alkoxycarbonyl chlorodisulfane, **36**, as the pivotal reagent. In this reaction both chloride, in the first step, and methoxycarbonylthiolate, in a second step, function as leaving groups. This method has been used to synthesize trisulfanes such as 2-hydroxyethyl *tert*-butyltrisulfane which is of interest as a petroleum additive. Employing a trisulfane as an intermediate or substrate to produce a new trisulfane has been the strategy exploited in a number of cases. For example, di-*tert*-butyltrisulfane reacts with trifluoromethylthio copper to give *tert*-butyl trifluoromethyltrisulfane, (**37**).⁵⁸



Alkoxides have also been used as leaving groups during the protocol A synthesis of the very novel alkoxytrisulfanes, **38**.⁵⁹ Care must be exercised in these reactions since tetrasulfanes are produced with more than one equivalent of thiol. Good to moderate yields of **38** can be obtained, however, suggesting that the reaction of the alkoxytrisulfane, **38**, with thiol is less favorable than the reaction of the thiol with the dialkoxy disulfane.

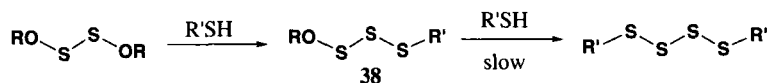

The use of hydrodisulfanes (e. g. **39**⁶⁰ and **40**⁶¹) as nucleophiles in protocol B procedures (Fig. 4) have been reported by several workers. Hydrodisulfanes are difficult to prepare in high purity (for an exception see reference 62) and as a consequence the disulfane anion is often generated in situ. Munavalli and coworkers⁶³ generated trifluoromethyl hydrodisulfane in situ by treatment of trifluoromethylsulfonyl chloride with H₂S. They report that the use of 4-dimethylaminopyridine as a catalyst to form bis(trifluoromethyl)trisulfane at -78° reduced the reaction time from 30 days to 1 day,

SYNTHESIS, PROPERTIES AND REACTIONS OF TRISULFANES AND THEIR OXIDES

undoubtedly reflecting the greater nucleophilicity of the disulfane anion. In this regard several substrates including thiosulfonates, **41**,⁶⁴⁻⁶⁶ Bunte salts, **42**,⁶⁷ and thiocarbonates, **43**,⁶⁸ have been used to generate the disulfane anion directly. In all of these reactions the disulfane anion subsequently attacks a molecule of substrate to produce the trisulfane.

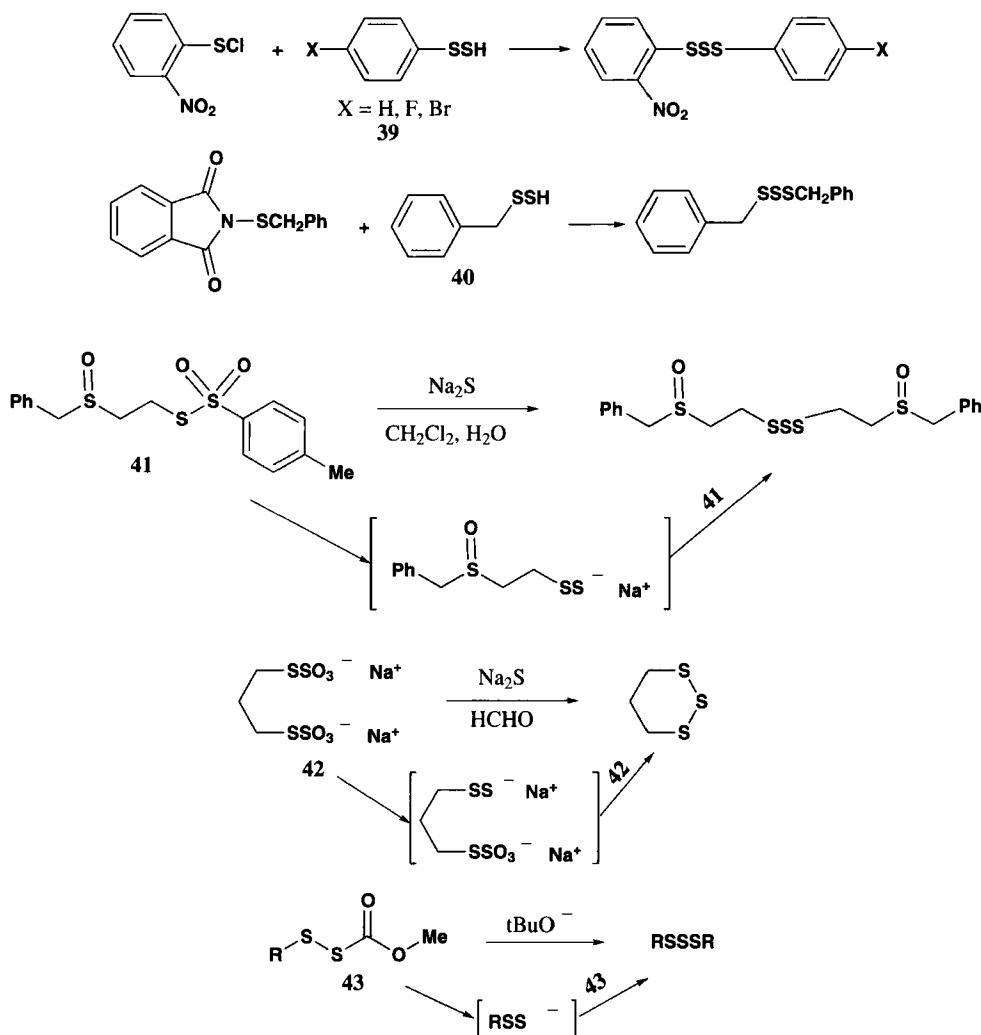

These reactions occur to give moderate to good yields of acyclic trisulfanes. Formaldehyde is included in the reaction of the Bunte salt to react with the liberated sulfite minimizing its reaction with the trisulfane.⁶⁷ An attempt to convert bithiocarbonates, **44**, to the cyclic trisulfane failed.⁶⁹ In the case of $n = 6-10$ only bis(trisulfanes) were isolated and when $n = 2-5$ oils were obtained which polymerized upon standing or attempted distillation.

Cappozzi and coworkers⁷⁰ introduced the use of bis(trimethylsilyl)sulfane to convert thiosulfonates and thiosulfonates to trisulfanes. These reactions (Figures 6A and 6B) both involve

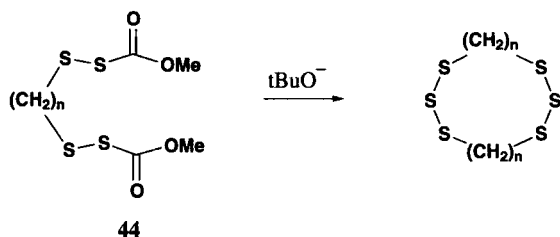

nucleophilic attack by an in situ generated trimethylsilyl disulfane. These reactions are attractive since they are accomplished under strictly neutral conditions with no formation of higher order polysulfanes.

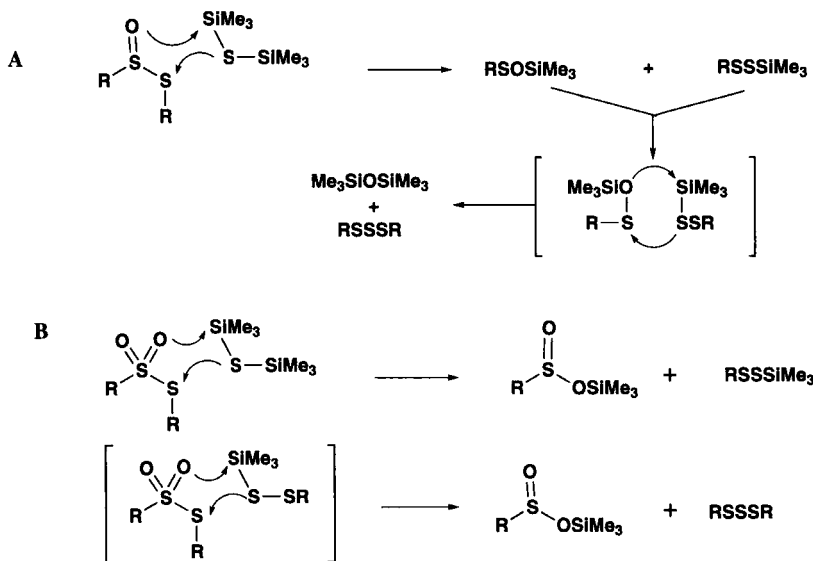
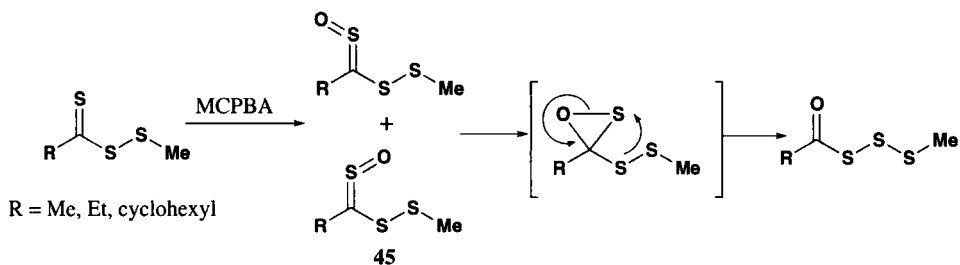

Fig. 6

In 1994 a new synthesis of acyltrisulfanes was reported which involved an unusual rearrangement of isomeric methyl trithioester sulfines, **45**.⁷¹ The sulfine substrates for these reactions were generated in approximately 70/30 E/Z ratios by MCPBA oxidations of methyl trithioesters. Attempts to generate sulfines with the methyl group replaced by ethyl, or benzyl failed. In these cases oxidation occurred both at the thiocarbonyl sulfur and at the sulfenyl sulfur adjacent to the alkyl substituent. The rearrangements of **45** were sluggish and required 10 days at room temperature. No information was given on which isomer (E or Z) was most reactive.



Simonet and coworkers^{72,73} reported a novel electrochemical process to generate trisulfanes involving electrooxidation of sulfur. Electrolysis of a sacrificial C/S anode (2 part sulfur; 1 part carbon) at 2.0 to 2.2 V versus SCE in a non-nucleophilic solvent generated solutions of S^{2+} which were stable for several days. Thiolates were then added to the S^{2+} solutions to generate the trisulfanes in good yield contaminated with variable amounts of di- and tetrasulfane byproducts.

Disulfanes are occasionally converted to trisulfanes by treatment with elemental sulfur. For example cystine can be converted to its trisulfane derivative by treatment with S_8 .⁷⁴ This procedure, however, is limited by a tendency of the trisulfane to overreact producing the pentasulfane. Trisulfane, **46**, reacts with S_8 in methanol or hexane/ Et_2NH to give the pentathiepin **47** in a clean equilibrium reaction characterized by an initial rate constant for disappearance of **47** of $2.1 \times 10^{-4} s^{-1}$ and a $K_{eq} = 46/47 = 54/46$.⁷⁵

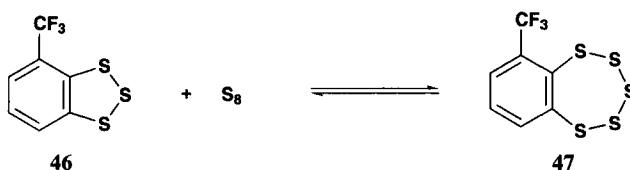

Elemental sulfur in conjunction with liquid ammonia has also been used to convert 4,8-disubstituted benzo[1,2-d; 4,5-d']bis[1,3]dithiole-2,6-dithiones, (**48**), to trisulfanes.⁷⁶ This reaction was conducted in a titanium autoclave and required 50 equivalents of sulfur to obtain the highest yield. The reaction appears to be somewhat limited in scope since it was unsuccessful in the absence of the 4,5-alkoxy groups.

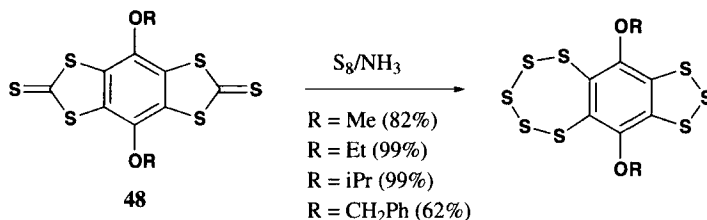

2. Formation of S-C Bonds

Nucleophilic substitution and the sulfuration of olefinic linkages are the two most prevalent methods of trisulfane formation which involve S-C bond formation as a key step. A simple bond disconnection analysis (Fig. 7) reveals that there are fundamentally two different protocols for the nucleophilic substitution reactions in which the identities of the nucleophilic and electrophilic components are reversed. In protocol A the trisulfane moiety bears the leaving group and functions as the electrophile. In protocol B the leaving group is attached to carbon and the trisulfane moiety functions as the nucleophile.

Protocol A (Fig. 7) is not often used, most likely as a result of the thermal instability of trisulfane chlorides. Harpp and coworkers⁷⁷ examined sulfane chlorides **49-51**, and reported that their

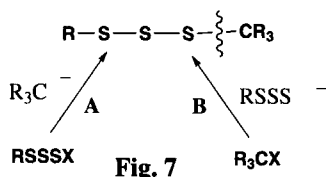

stability decreases with increasing sulfur content. Nevertheless **51** had sufficient stability to allow reaction with either *n*-butyl lithium or Grignard reagents to give *n*-butyl triphenylmethyltrisulfane (**52**).

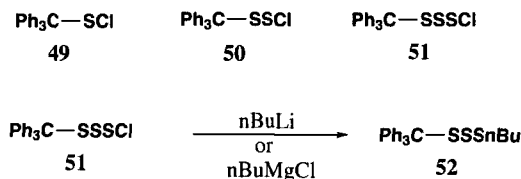

The use of alkyl halides (Protocol B; Fig. 7) as substrates is the most often encountered nucleophilic substitution strategy to construct the S-C bond in trisulfanes. For example, methylene chloride and $\text{Na}_2\text{S}_{2.5}$ react to give a trisulfane at pH 8 but not at pH 12.⁷⁸ (Fig. 8) Other examples include the reactions of " K_2S_n " (generated in situ by reaction of S_8 with KOH in THF with either a trace of water or a phase transfer catalyst) with *iso*-propylbromide, allyl chloride, and 1,3-dibromopropane to give trisulfanes **53-55**, respectively.^{79,80} Sodium tetrasulfide has been reported to convert dichloride **56**, into the trisulfane⁸¹ and S_8/NH_3 reacts with aromatic tetrabromide **57**, in what is described as a nucleophilic substitution to give the aromatic trisulfane **58**.⁸²

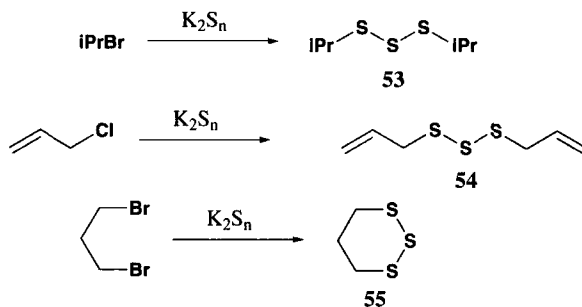
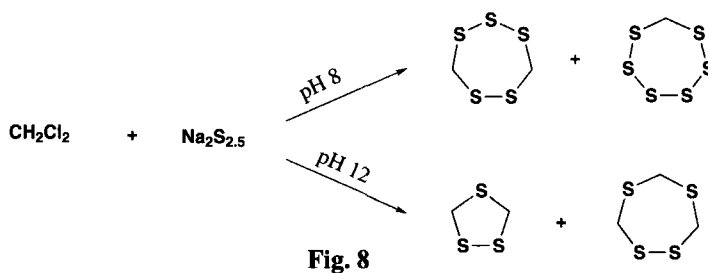

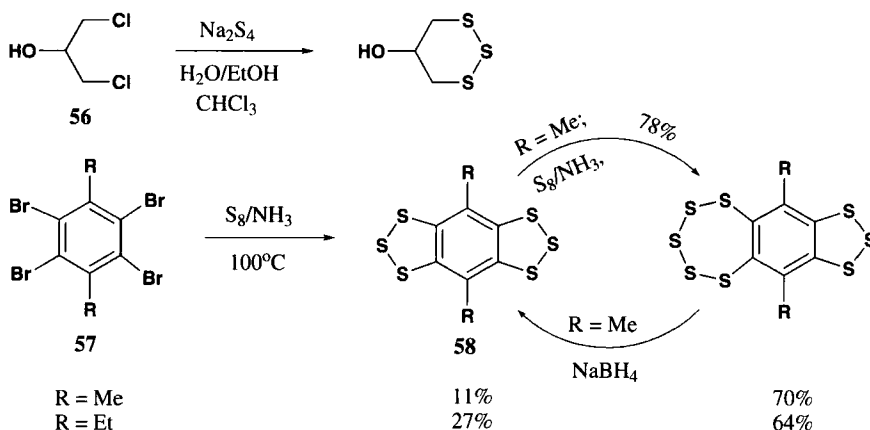

Sulfuration of olefinic linkages has been primarily accomplished using one of two strategies; (1) with elemental sulfur activated thermally, photochemically, or by the addition of chemical additives (NH₃, DMF, DMSO, pyridine, triethylamine, etc.), or (2) with sulfur transfer agents. The application of these two methods for the construction of trisulfanes suffers from the facts that the factors which make olefins susceptible to sulfuration have not been established and the identity of the actual sulfuration agent, under most of the reported experimental conditions, remains unknown. The identification of the sulfuration agent is complicated by the fact that the number of molecular forms of sulfur is extremely large.^{1,83} At temperatures below 95° S₈ is the thermodynamically stable form of sulfur. However, it is likely that under many of the experimental conditions utilized in the literature smaller unstable sulfur molecules such as S₂, S₃, or S₄ act as the kinetically active sulfuration agent. In addition, under the chemically activated conditions, sulfuration agents representing some composite formulation of sulfur and the additive may also play a role.

Thermal activation of sulfur has rarely been used for sulfuration of olefinic linkages since either photochemical or chemical activation provides milder conditions. Nevertheless, reports of thermally activated reactions have been reported. For example, sulfuration of tetrafluoroethylene proceeds at 445° to give both a trisulfane **59**, and a tetrasulfane.⁸⁴ Rys and Harpp⁸⁵ pointed out that sulfuration of acyclic dienes such as **60** in nonpolar solvents only occurs at temperatures in excess of 130°. In contrast, sulfuration in the presence of pyridine or DMSO requires lower temperatures. BHT had no influence on these reactions and consequently all radical processes were eliminated from mechanistic consideration. These authors instead suggested that the nucleophilic additives catalyze the reaction by cleaving S₈ to generate a more active sulfurating agent, **61**, and/or form the very reactive small sulfur molecules S₂, S₃, S₄, etc. Fritz and Weis,⁸⁶ in another example of the beneficial effects of additives, reported that the yield of trisulfane, **62**, from sulfuration of cycloheptatriene increased from 11 to 21% when pyridine was included in the reaction mixture. Sulfolane was the preferred solvent for this reaction and reduced yields of **62** were observed in DMF or DMSO.

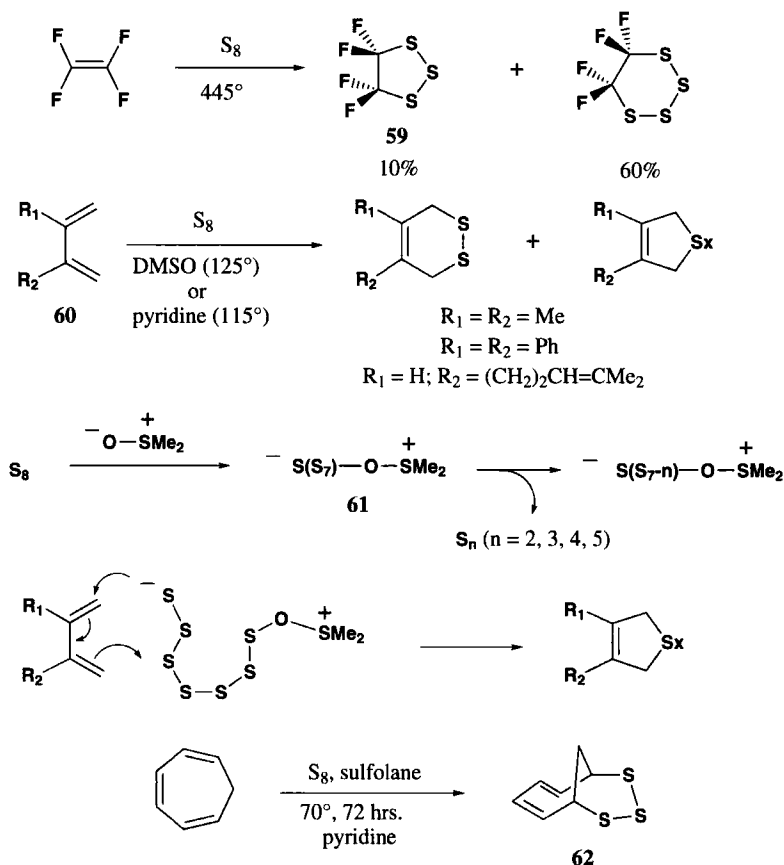

The sulfuration of norbornene, (**63**), was initially reported to give the trisulfane, **64**, as the exclusive product. Bartlett and Ghosh,⁸⁷ however, demonstrated that the trisulfane, **64**, and pentasulfane **65**, formed in a 3:1 ratio in DMF or DMSO. This ratio appears to be a result of the equilibration of **64** and **65**. Addition of a pure sample of **65** to DMSO generated **64/65** in the same ratio as observed in the direct reaction. The equilibrium was also established starting with **64** and S_8 , but only slowly because of the low solubility of S_8 in DMSO.

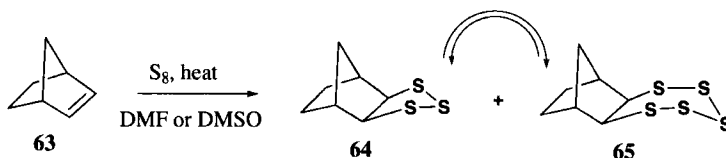

Bartlett and Ghosh⁸⁷ also examined the sulfuration of norbornadiene, **66**, and demonstrated that even in the presence of additives the reaction conditions were sufficiently harsh to mask the initial product composition. Reaction of S_8 with **66** at 100° in DMF in the presence and absence of NH_3 , with and without added BHT, resulted in the formation of five products, **67-71**. Reaction of **66** with the more reactive heptasulfane imide, **72**,^{88,89} however, generated only trisulfane **70** and a pentasulfane,

73. These results implicate **73** as the precursor to **67-71**.

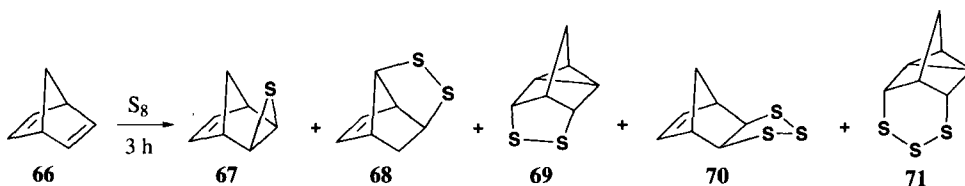

DMF, 100°	20	18	14	33	15
DMF, NH ₃ , 100°	15	12	12	57	4
DMF, BHT, 100°	25	18	15	38	4

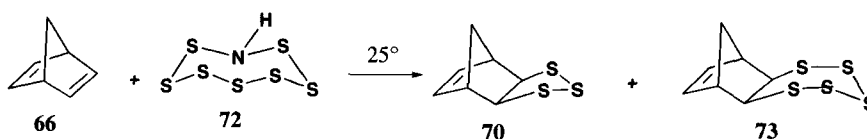

Photochemical activation of S₈ circumvents the need for high temperatures and presumably has the potential of producing less complicated reaction mixtures. That is indeed the case with norbornene which gives the trisulfane as the major product when irradiated in the presence of S₈ in CS₂ at 350nm.⁹⁰ A small amount of episulfide, **74**, appears to be a secondary product formed from photolysis of **64** because direct irradiation of **64** in benzene produces both **74** and **75**. This reaction is very different from the thermal reaction since it is unaffected by the addition of NH₃. Unfortunately, the

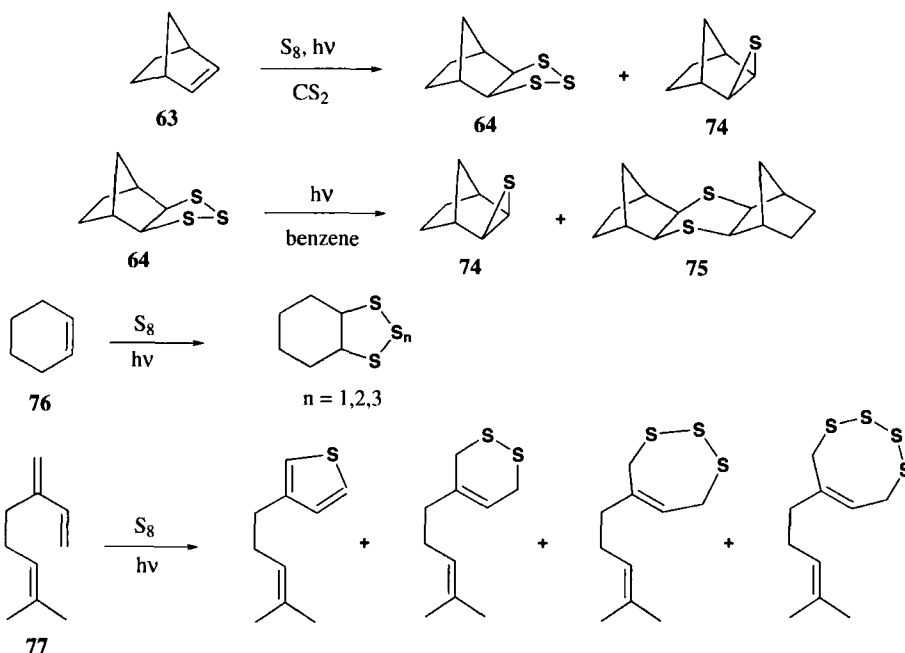

formation of simple reaction mixtures during photochemical activation is not realized in several other cases. Photochemical sulfuration of both cyclohexene, (**76**),⁹⁰ and myrcene, (**77**),⁹¹ give mixtures of polysulfane products.

Sulfur transfer agents are attractive for sulfuration reactions since conceptually they should be able to deliver discrete sulfur atoms or molecules, S_n ($n = 1,2,3...$). In practice, however, the smaller sulfur molecules such as S_2 are very reactive and will react in many cases with the initially formed sulfane to give polysulfane products.⁹²

Heating the sulfur transfer agents, **78a** or **78b**, at 100° in benzene resulted in very clean S_3 transfer to acceptor olefins.⁹³ The reaction of **78a** with norbornene was unaffected by the presence of the free radical inhibitor 2,4-di-*tert*-butyl-*p*-cresol ruling out a long chain length process involving a reactive free radical. In addition, trisulfane, **78a**, does not undergo any decomposition at 100° in the absence of an acceptor implicating a bimolecular reaction. A kinetic analysis of the reactions of **78a** and **78b** with norbornene is consistent with this suggestion giving bimolecular rate constants of $2.02 \times 10^2 \text{ M}^{-1}\text{min}^{-1}$ and $7.14 \times 10^2 \text{ M}^{-1}\text{min}^{-1}$, respectively. The small rate enhancement for the reaction of the *p*-methoxyphenyl substituted sulfur transfer agent, **78b**, is inconsistent with significant ionic character in the S_3 transfer transition state. The absence of any significant ionic character in the reaction is also supported by the fact that the bimolecular rate constant for the reaction of **78a** with norbornene is identical in benzene ($\epsilon = 2.5$) and in nitrobenzene ($\epsilon = 35$). In addition, the activation parameters ($E_a = 27.8 \text{ kcal/mol}$ and $\Delta S^\ddagger = -2.9 \text{ eu}$) for the reaction of **78a** with norbornene do not support a unimolecular dissociation to give S_3 followed by its reaction with norbornene. All of these results support a concerted transfer of S_3 via a bimolecular process.

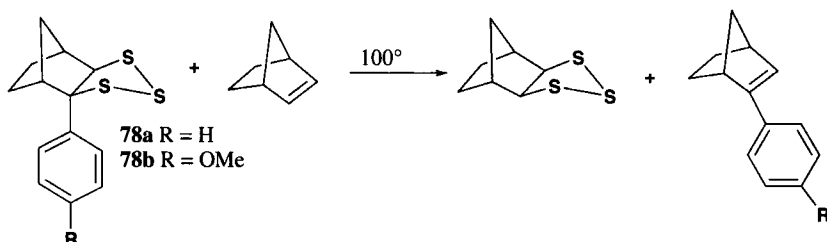

Trisulfanes **78a** and **78b** are far superior to trisulfane **79**, which does not react as an S_3 donor at all, and to trisulfane **80**, which only gives 14% S_3 transfer to norbornene under conditions where the transfer from **78a** was quantitative. These results suggest that the electronic character of the aryl groups in **78a** and **78b**, rather than their steric bulk, is responsible for their donor properties. A brief examination of acceptor ability of various olefins reveals the following; norbornene > norbornadiene \approx benzonorbornene > 2-methyl-2-norbornene.

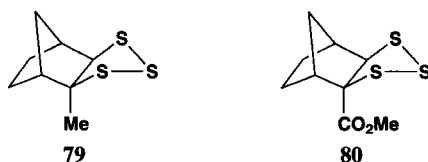

SYNTHESIS, PROPERTIES AND REACTIONS OF TRISULFANES AND THEIR OXIDES

The reactions of S_2 with strained olefins (e. g. **63**, and **81**) and some dienes (e. g. **82**) have been reported to give moderate to very good yields of trisulfanes. A large number of S_2 transfer agents are available to accomplish these transformations.^{92, 94, 95, 96, 97, 98} Evidence that S_2 rather than S_8 is the active species was provided by the observation that acenaphylene, (**83**) reacts with a S_2 transfer agent but not with molecular sulfur to give trisulfane **84**.⁹⁶

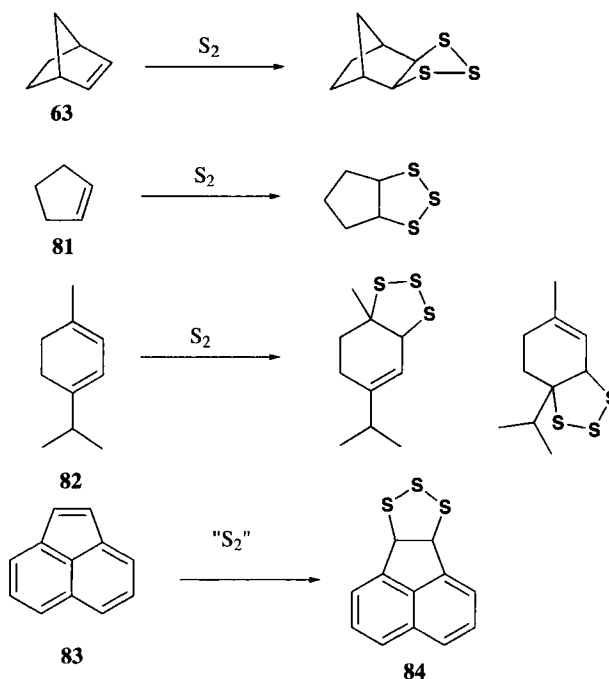

Steliou and coworkers have suggested that S_2 mimics in many ways the reactivity of singlet oxygen. Consequently, they have proposed that S_2 adds to norbornene in a 2 + 2 cycloaddition to give a strained 1,2-dithietane, **85**, which is converted to the trisulfane by reaction with a second molecule of S_2 .⁹⁹ A similar insertion has been suggested to occur with the disulfane, **86**, which forms by 4 + 2 cycloaddition of S_2 to cyclopentadiene.⁹⁹ A subsequent [3.3] sigmatropic shift followed by loss of sulfur results in formation of the trisulfane. However, the involvement of a discrete S_2 molecule in these reactions is not universally accepted.¹⁰⁰

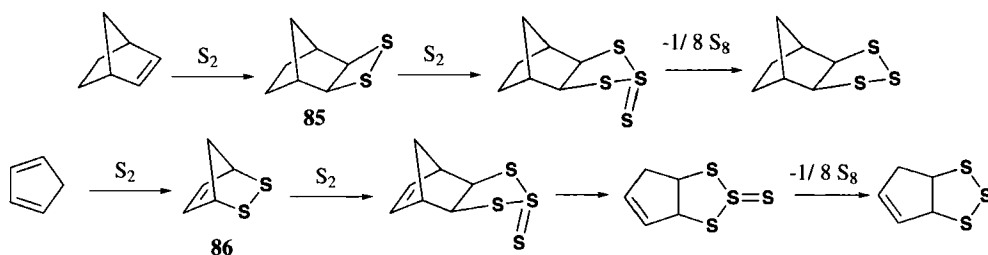

III. REACTIONS OF TRISULFANES

1. Thermolysis

For convenience we will discuss thermal reactions of trisulfanes in terms of 4 broad classifications; (a) disproportionations and exchanges, (b) sulfur expulsions, (c) rearrangements, and (d) pyrolysis.

a. Disproportionations and Exchanges

Disproportionation of dimethyltrisulfane, (**87**), leads to 50% conversion after 5.2 hours and complete conversion to an approximately 1:1 mixture of the disulfane and tetrasulfane after 500 hours at 80°. Exchange reactions can occur in both inter- and intramolecular senses and are distinguishable from disproportionation reactions since they generate the trisulfanes exclusively. For example, diethyl- and di-n-propyltrisulfane undergo intermolecular exchange at temperatures between 130° and 150° to give ethyl n-propyltrisulfane, (**88**), in a reaction which appears to approach an equilibrium distribution of products.¹⁰¹ Small amounts of di- and tetrasulfanes are also formed in a slower competing disproportionation reaction. Trisulfane **35** undergoes an intramolecular exchange reaction at 110° in 72 hours to give a statistical ratio of trisulfanes.¹⁰² Addition of AIBN to **35** allows this equilibrium to be established at 100° in a much reduced time of only 16 hours.

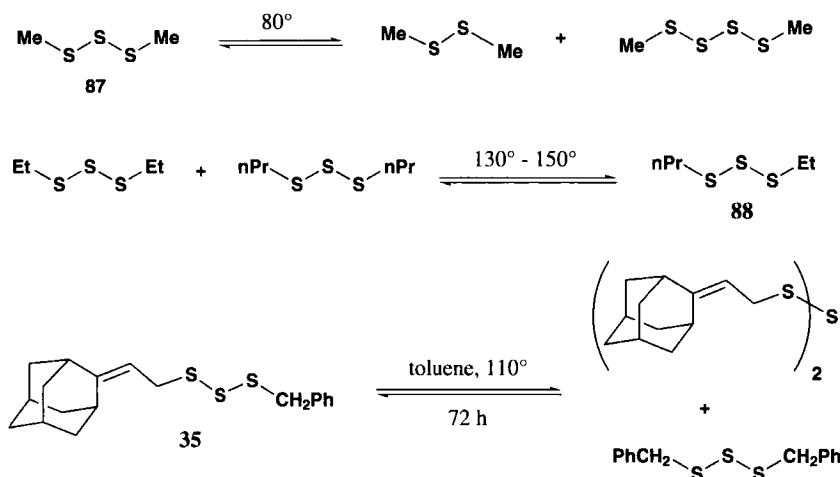

Steudel¹ has discussed in detail three mechanisms which have been considered for these reactions. Mechanism A (*Fig. 9*) is a free radical chain reaction. The exclusive formation of trisulfanes in the exchange reactions requires that RS^\cdot attack solely at the central sulfur atom. At higher temperatures an increasing number of initiation steps, and an increased propensity to attack at the terminal rather than at the central sulfur, would lead to the thermodynamically defined disproportionation reaction mixture. Steudel¹ has criticized this mechanism since experimentally derived activation barriers for S-S homolytic cleavage are considerably smaller than measured activation barriers for disproportionation and exchange reactions. (e. g. 29 kcal/mole for the exchange to form **88**)¹⁰¹

SYNTHESIS, PROPERTIES AND REACTIONS OF TRISULFANES AND THEIR OXIDES

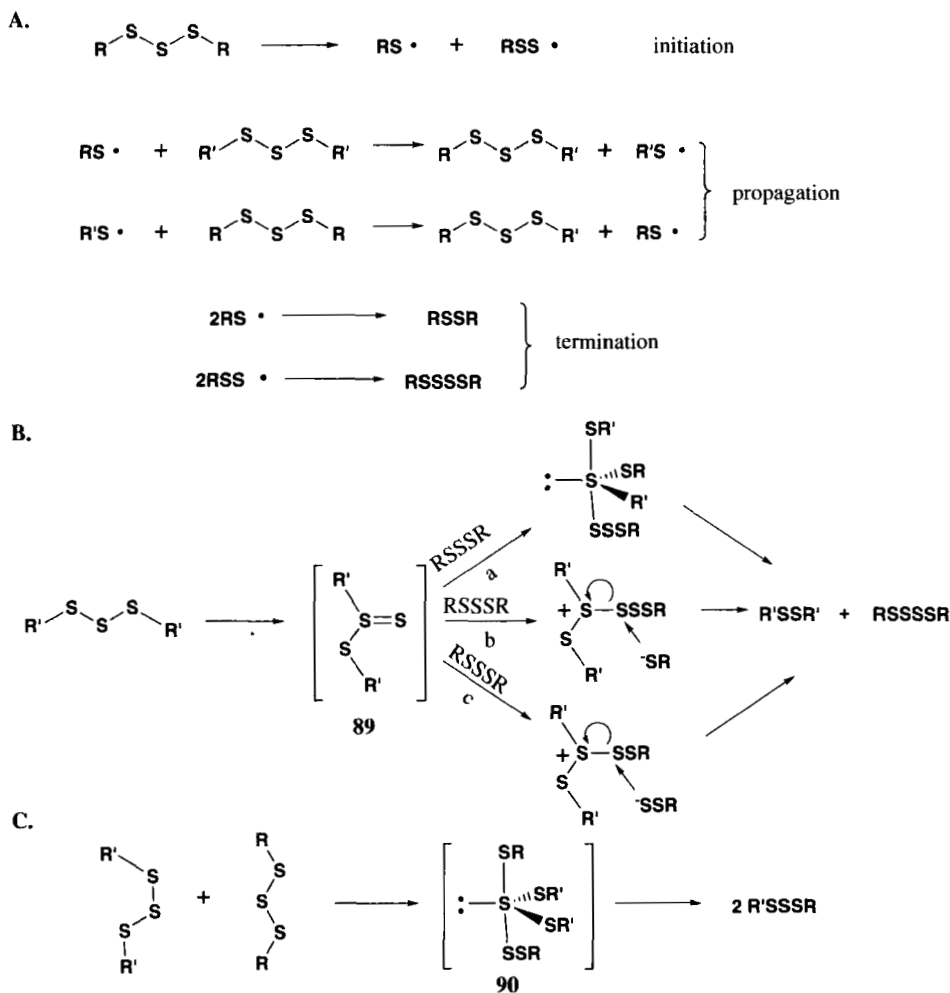

Fig. 9

Mechanism B for the disproportionation reaction (e. g. the reaction of **(87)** at 80°C) involves prior isomerization to a thiosulfoxide-like intermediate **89**. Bimolecular conversion to products can either proceed *via* $2 + 2$ addition across the S=S bond to give a sulfurane (path a), or by nucleophilic attack at the central (path b) or terminal (path c) sulfur atoms. (Fig. 9) Path c in Fig. 9B could also serve as a mechanism for the exchange reaction if nucleophilic attack occurs at the boldface sulfur in the intermediate. Mechanism C for the exchange reaction does not require prior isomerization to a reactive intermediate but occurs by a direct insertion into the S-S bond. Pseudorotation of the sulfurane intermediate, **90**, followed by decomposition would give a statistical mixture in either the inter- or intramolecular exchange reaction.

b. Sulfur Expulsions

Sulfur expulsions, often enhanced by increasing solvent polarity, have been observed for both trisulfanes and some of their oxidized derivatives. These reactions generally result in the precipi-

tation of S_8 . For example, trisulfane **91**¹⁰³ and trisulfane-1,1-dioxide **92**¹⁰⁴ spontaneously lose sulfur concomitantly with formation of the corresponding disulfane and disulfane-1,1-dioxide. Harpp¹⁰⁵ has suggested that these reactions proceed *via* a branched thiosulfoxide intermediate, **93**, which can abstract sulfur and eventually decompose to either S_2 or S_8 .

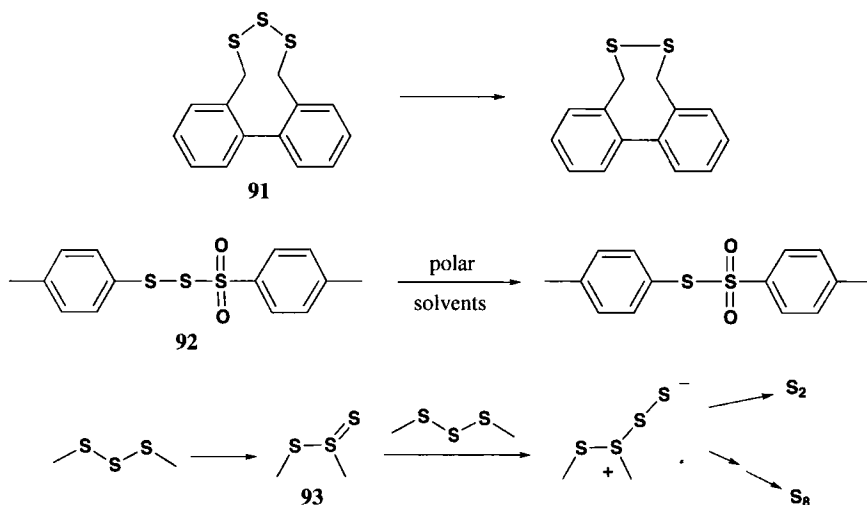

c. Rearrangements.

Rearrangements by definition are molecular transformations which provide an isomer of the starting material. These reactions are rare for trisulfanes and their derivatives, however, the reactions of **94** and **95** provide two classic examples.

Trisulfane **94** was separated by fractional recrystallizations into racemic and meso diastereomers.¹⁰⁶ The isomer of higher melting point (33.5 – 34°), however, isomerizes at 75° into the original diastereomer mixture with a $t_{1/2}$ of 46.5 minutes. The reaction was characterized by several unique features including: (1) the absence of any di- or tetrasulfane formation, (2) no solvent effect as the solvent was changed from benzene to methanol, (3) no effect of added BHT (2,6-di-*tert*-butyl-*p*-cresol) or oxygen, (4) the absence of any trisulfane (e.g. **96**) from allylic rearrangement, and (5) the absence

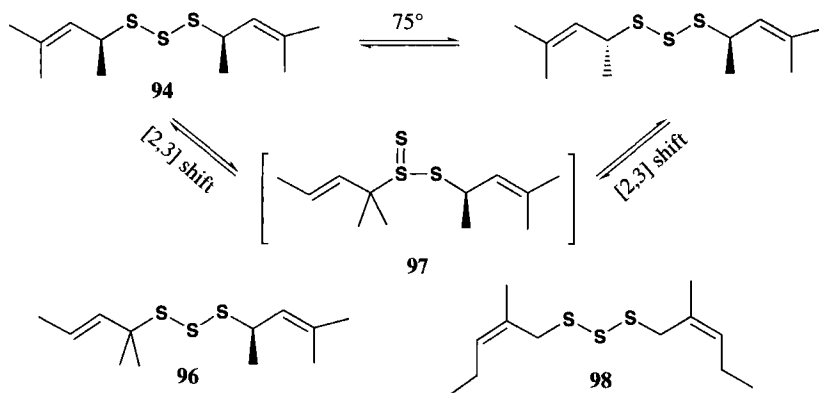

of any concentration effect. These observations led to the suggestion that the reaction occurs by sequential 2,3-shifts *via* a thiosulfoxide-like intermediate, **97**. Consistent with this suggestion was the observation that the activation entropy ($\Delta S^\ddagger = -7$ e.u.) for the reaction of **94** is very different from that expected for homolytic scission of the S-S bond ($\Delta S^\ddagger = +24.6$ e.u.) but very similar to the entropy of activation observed for the sulfoxide-sulfenate rearrangement. In addition, the double bonds in trisulfane **98** appear to isomerize with a rate constant very similar to that for the meso-racemic diastereomer interconversion in **94**.

Aryl trisulfane-2-oxide, **95**, when irradiated at wavelengths greater than 300 nm undergoes a quantitative rearrangement to the trisulfane-1-oxide.¹⁰⁷ The reaction appears to occur *via* the excited singlet state since it is not quenched in the presence of the triplet quenchers, oxygen, 1,3-cyclohexadiene, or 1,3-pentadiene. The reaction does not occur thermally or in the presence of a few drops of trifluoroacetic acid. Irradiation of oxygen-18 labeled **95** (R = Me) resulted in formation of the 2-oxide with quantitative retention of the labeled oxygen. The oxygen migration is intramolecular since photolysis of an equimolar mixture of oxygen labeled **95** (R = Me) and **95** (R = Et) did not generate crossover product (i.e. oxygen labeled **95** R = Et). In addition, photolysis of the 1-oxide did not result in formation of the 2-oxide. A mechanism involving 1,2-migration without cleavage of a S-S bond has been proposed for these reactions, however, mechanisms invoking S-S cleavage cannot be unambiguously ruled out.¹⁰⁸

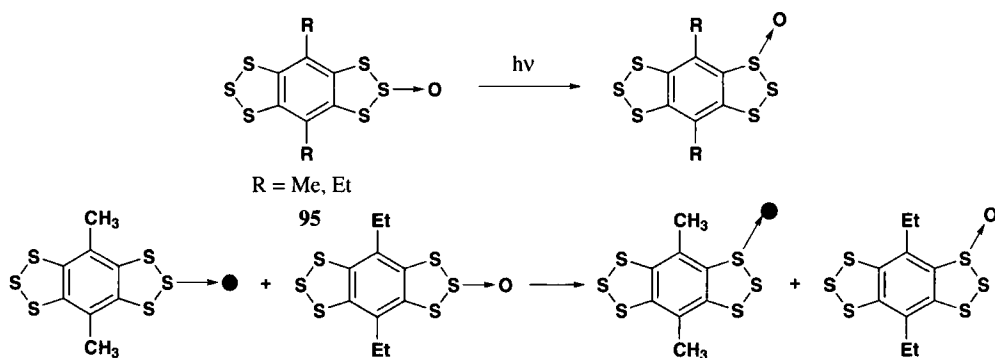

d. Pyrolysis.

Gas phase pyrolysis of both di-*n*-propyl-, (**99**),¹⁰⁹ and di-*n*-butyl-, (**100**),¹¹⁰ trisulfanes have been reported. The product distributions reveal a very complicated process which has not yet been explored in detail. Gas phase pyrolysis of diethyltrisulfane, (**101**), in the presence of acetylene gives an interesting mix of thiophene and fused bis-thiophenes.¹¹¹

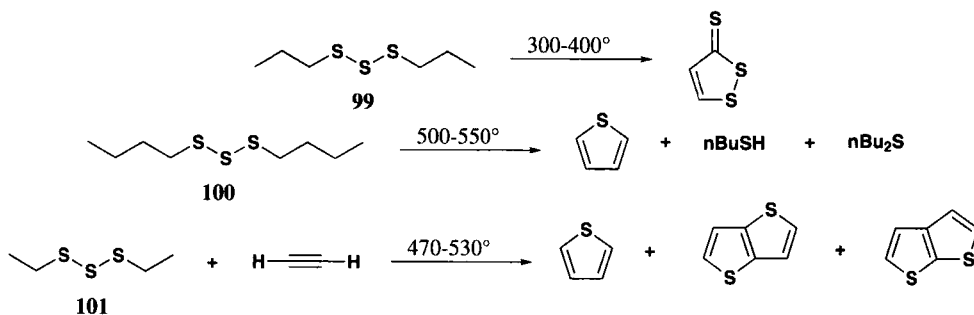

2. Nucleophilic Cleavage

Nucleophilic displacements in trisulfanes can occur by either C-S cleavage or more frequently by S-S cleavage. The S-S bond cleavage in unsymmetrical trisulfanes can potentially occur by attack at the central sulfur atom (paths a and b in Fig. 10) or at a terminal sulfur atom (paths c and d in Fig. 10). The initially formed products subsequently react in a manner dictated by the identities of the substituents R- and R'- and by the nature of the nucleophile.

The propensities of nucleophiles to cleave the S-S bond in disulfanes, and to a lesser extent in trisulfanes, have been extensively examined. Field¹⁷ pointed out that the relative thiophilicity towards sulfur in a S-S bond decreases in the following order $(\text{EtO})_3\text{P} > \text{R}^-; \text{HS}^-; \text{EtS}^- > \text{PhS}^- > \text{Ph}_3\text{P}; \text{CN}^- > \text{SO}_3^{2-} > \text{OH}^- > 2,4\text{-(NO}_2)_2\text{PhS}^- > \text{N}_3^- > \text{SCN}^-; \text{I}^-; \text{PhNH}_2$. The complicated structural and environmental factors which dictate this reactivity order and the merits of different thiophilicity scales (correlation's) were examined in detail by Davis.¹² The rate of nucleophilic attack of course depends both on the nature of the nucleophile and the substrate. Even the reasonably non-thiophilic molecule NH_3 will attack a trisulfane which contains strong electron withdrawing substituents.¹¹³ However, the most frequently utilized nucleophiles (thiophiles)¹⁹ for reactions with trisulfanes are the thiolates (RS^-) and the trivalent phosphorus compounds (R_3P). The unique features of nucleophilic cleavage reactions using these thiophiles and others thiophiles are examined in the following discussion.

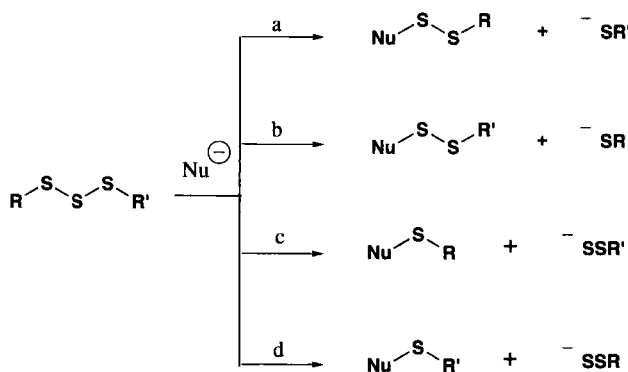

Fig. 10

Harpp and coworkers^{42,114,115} have suggested that phosphites ($P(OR)_3$), tris(dialkylaminophosphines ($P(NR_2)_3$), and triaryl- and trialkylphosphines react with trisulfanes *via* attack at both the central and terminal sulfur atoms in a two step process to give disulfanes and phosphine sulfanes. The second step in reactions initiated by attack at the central sulfur atom (a and b in Fig. 10) involves collapse of the ion pair by attack of RS^- at the S-S bond of R_3P^+-SSR to give the disulfane $RSSR$ and $R_3P=S$. The second step of the reactions initiated by attack at the terminal sulfur atom (c and d in Fig. 10) involves S_N2 substitution at the R- group in R_3P^+-SR to give the disulfane and $R_3P=S$. Harpp and Smith¹¹⁵ also pointed out that either step 1 or step 2 can be rate determining and discussed these reactions in terms of the qualitative reaction surfaces given in Fig. 11.

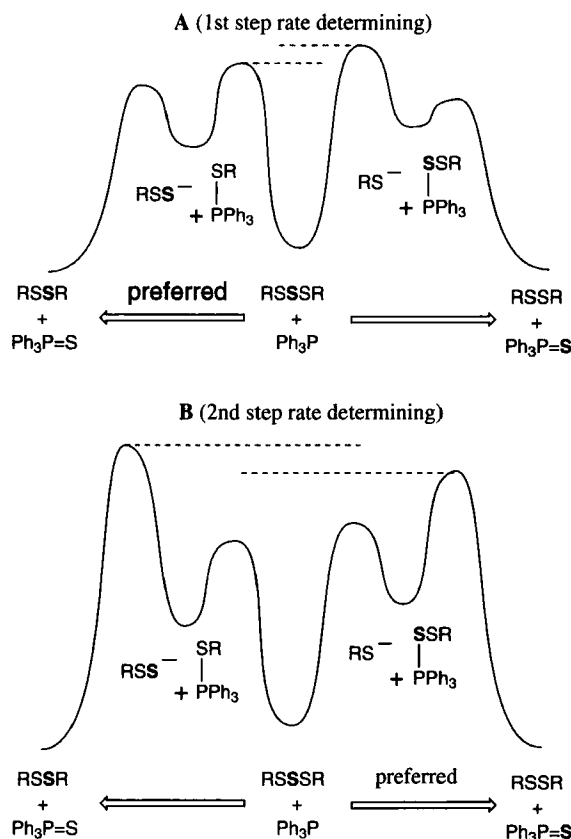
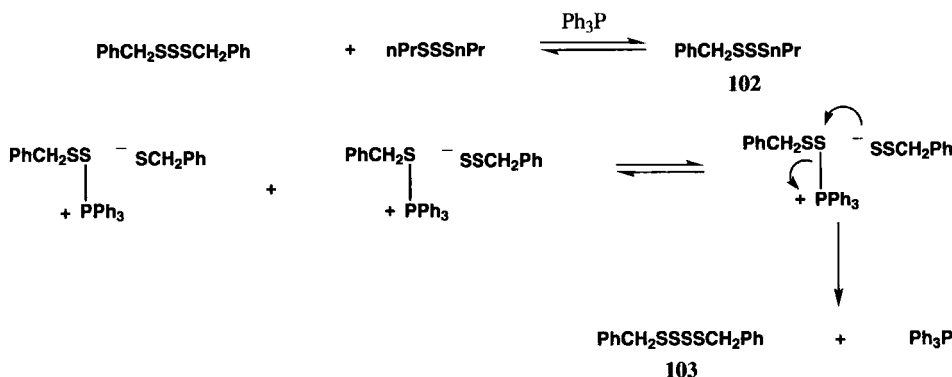

Fig. 11

In those reactions in which the first step is rate determining (A in Fig. 11) formation of $RSSR$ is thermodynamically and kinetically preferred over RS^- formation. Consequently, in these reactions the terminal sulfur ends up in the $R_3P=S$ product. In contrast, in the reactions where the second step is rate determining (B in Fig. 11) nucleophilic attack to cleave the S-S bond in the ion pair is kinetically preferred over S_N2 substitution at R to cleave a S-C bond. Consequently, in these reactions the central sulfur atom ends up in the $R_3P=S$ product. (Fig. 11) The use of radiolabeled dibenzyltrisulfane

($\text{PhCH}_2\text{S}^{35}\text{S}-\text{SCH}_2\text{Ph}$) has allowed a determination of which of these mechanisms operates in a given situation. For example, aminophosphines ($(\text{R}_2\text{N})_3\text{P}$) in medium polarity solvents react *via* the reaction coordinate given in *Fig. 11A*, while triphenylphosphine (Ph_3P) reacts *via* the reaction coordinate given in *Fig. 11B*.

These mechanistic conclusions were corroborated in several ways. For example, Ph_3P catalyzes an exchange between dibenzyltrisulfane and di-*n*-propyltrisulfane to give trisulfane **102** prior to a slower formation of desulfurization products. This most likely occurs *via* equilibration of ion pairs formed prior to the rate determining second step. Consistent with the ability of ion pairs to equilibrate is the observation that 7% of a tetrasulfane, **103**, is formed in the reaction of Ph_3P with dibenzyltrisulfane.



The extent of central versus terminal sulfur removal is solvent *independent* for Ph_3P . In contrast, the % incorporation of the central sulfur atom into tris(dimethylamino)phosphine sulfide ($(\text{Me}_2\text{N})_3\text{P}=\text{S}$) during the reaction of $(\text{Me}_2\text{N})_3\text{P}$ with (+)-(R,R)-Bis(1-phenylethyl)trisulfane is dramatically solvent *dependent* as depicted in *Fig. 12*. The gradual decrease in % central sulfur removal as the solvent is changed from acetonitrile ($E_T = 46.0$) to benzene ($E_T = 34.5$) is disrupted at $E_T \approx 35$, and a further decrease in solvent polarity actually produces an increase in % central sulfur removal. It was suggested that this deviation signaled a change in mechanism. Candidates for the new mechanism might involve a thiosulfoxide intermediate, **93**, or a pentacovalent phosphorus intermediate formed

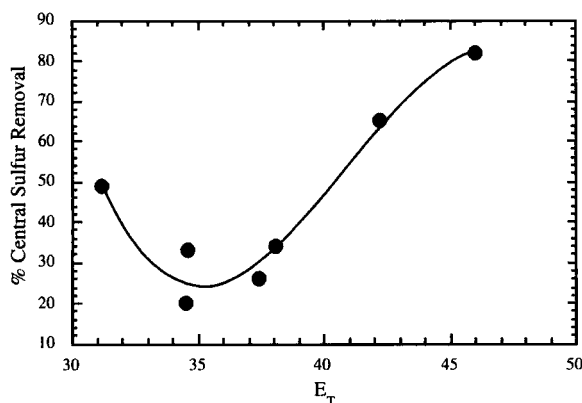
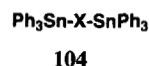

Fig. 12

via insertion into the S-S bond. Biphilic insertions of phosphines into peroxide linkages have previously been reported.¹¹⁶ They are characterized by Hammett ρ^+ values much smaller than observed for nucleophilic reactions consistent with little charge separation in the transition states for the reactions.

Trivalent phosphorus compounds provide a convenient synthetic procedure for desulfurization of trisulfanes but suffer from a lack of selectivity. To address this concern the use of bis(triphenylstannyl)chalcogenides, **104**, were introduced.¹¹⁷ The reactivity of these desulfurizing agents decreases in the order **104** (X = Te) > **104** (X = Se) > **104** (X = S). Desulfurizing agent **104** (X = Te) smoothly monodesulfurizes bis(p-methylphenyl) trisulfane in 4 hours at 0° while **104** (X = S) did not react under identical conditions even in refluxing acetonitrile. Desulfurization of a mixture of two symmetric trisulfanes resulted in formation of the expected symmetric disulfanes and a considerable amount of the mixed disulfane revealing that the reaction occurs in an intermolecular fashion.



Thiols when incubated with Calicheamicin γ_1 , (**1**), have been shown to initiate the cleavage of double stranded DNA.^{3,4} The nucleophilic attack of the trisulfane functional group by a thiol initiates a series of reactions which culminates in the formation of a 1,4-diyll, **105**, which interacts with DNA by hydrogen abstraction.

An *ab initio* study demonstrated that the gas phase reactions of thiols with trisulfanes occur with a preference for attack at the terminal sulfur *via* an addition-elimination mechanism.¹¹⁸ Attack at the terminal sulfur is kinetically preferred to attack at the central sulfur as a result of a less sterically demanding approach, and is thermodynamically favored as a result of the thiosulfenate being a better leaving group than the thiolate. Nevertheless, a detailed study of the reaction of **1** with glutathione has shown that nucleophilic attack occurs at all three sulfurs.¹¹⁹ The energetic preference for terminal sulfur attack in the *ab initio* study, however, is small enough that solvation could easily result in competitive attack at all the sulfurs consistent with the experimental results.

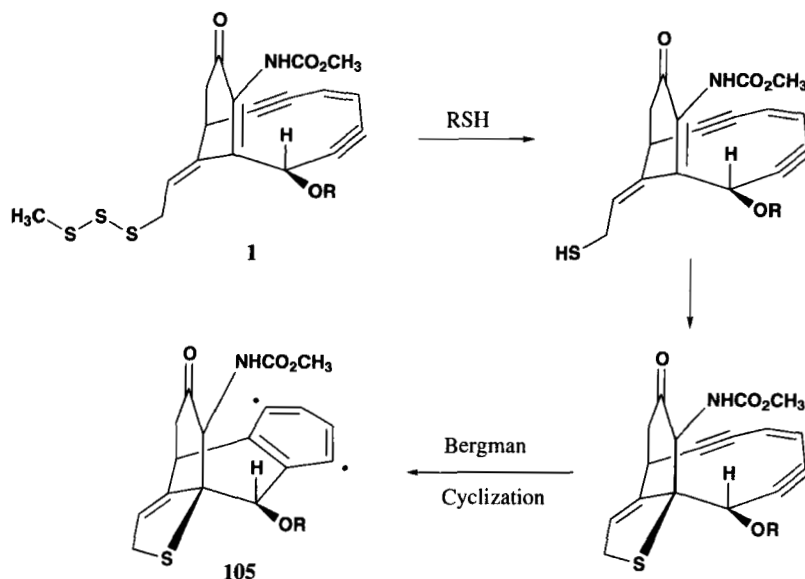

Nucleophilic cleavage of C-S bonds in trisulfanes is rare but does occur in trisulfanes and their oxides with very electrophilic substituents. For example, the reactions of $\text{CF}_3\text{SSSCF}_3$ with either organolithiums¹²⁰ or Grignard reagents¹²¹ has been suggested to occur with simultaneous cleavage of both C-S and S-S bonds. The authors have suggested that a single electron transfer process may play a role in these reactions. Another example involves the cleavage of the carbomethoxy group in trisulfane-1,1-dioxide, **106**, by methoxide.¹²²

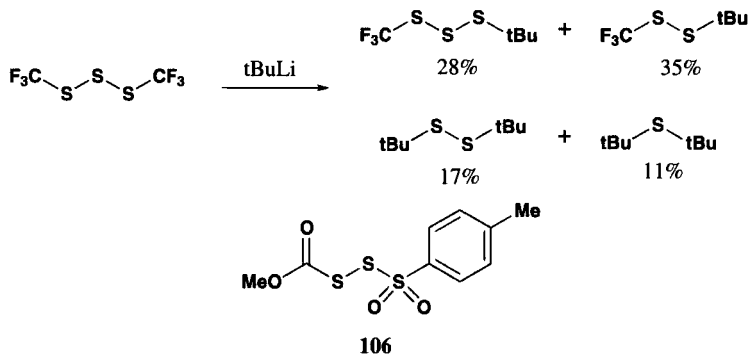

3. Oxidation

Trisulfanes can be oxidized by many of the oxidants known to convert monosulfanes to sulfoxides and sulfones.¹²³ In the case of a symmetrical trisulfane twenty oxidized derivatives with up to four oxygen atoms can be envisioned including pairs of diastereomers for **109**, **110**, **117**, and **118**, and a set of three diastereomers for **113**. In fact, trisulfane oxides are considerably less stable than the sulfoxides and sulfones isolated from monosulfanes and many of the trisulfane isomers have never been observed. Some have tenuous spectral data to support their existence, but only a few have actually been isolated and their structures determined by X-ray crystallography.

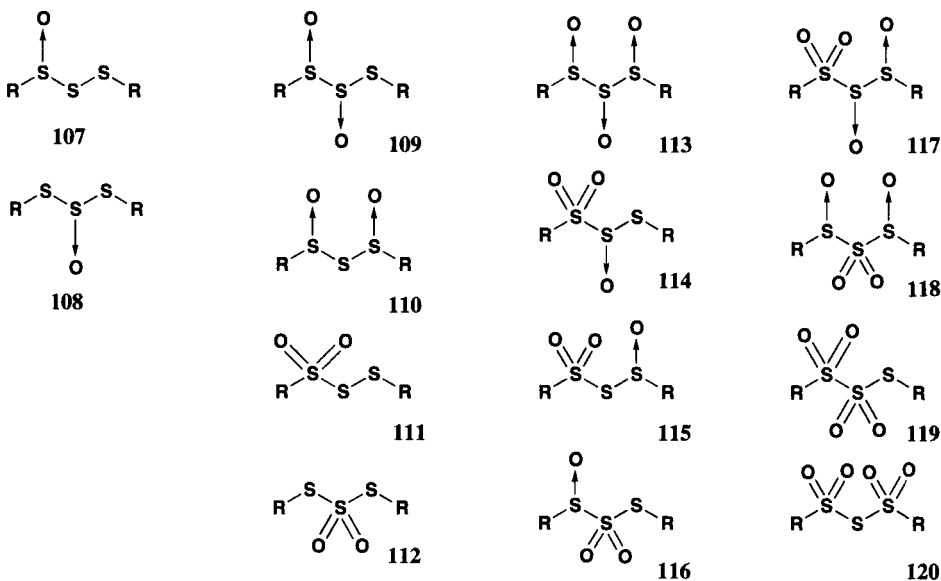

a. Trisulfane-monooxides 107 and 108.

Acyclic trisulfane 1- and 2-oxides are spectroscopically characterized compounds with limited thermal stability. These monooxides are stabilized by tertiary substituents.^{124, 125} For example, di-*tert*-butyltrisulfane-1-oxide requires 12 hours at 45° to completely decompose¹²⁵ while bis(*p*-methoxyphenyl)trisulfane-1-oxide has a half-life of only 69 minutes at room temperature.³⁸ Di-*iso*-propyltrisulfane-2-oxide has a half-life of only 15 minutes at 100° while di-*tert*-butyltrisulfane-2-oxide has a half-life in excess of 22 hours at the same temperature.¹²⁴

Steudel and Drozdova¹²⁶ reported ab initio calculated structures of various rotomers of dimethyltrisulfane-1- and 2-oxides. The most stable rotomer of the 1-oxide contains a helical CSSSC backbone with the two methyl groups in a “trans” relationship (i.e. the methyls are on opposite sides of a plane defined by the three sulfur atoms). The most stable rotomer of the 2-oxide has C₁ symmetry and contains a near planar CSSS chain with the second carbon rotated away from the plane by 75° and the oxygen by 54°. The 2-oxide is less stable than the 1-oxide by 2.6 kcal/mol. It is likely however that the relative stabilities of these isomers will be a sensitive function of the substituents. In the case of H₂S₃O, the 2-oxide is more stable than the 1-oxide by more than 7 kcal/mol.¹²⁶

Trisulfanes are successfully oxidized with a variety of oxidants including metachloroperbenzoic acid (MCPBA),¹²⁷ dimethyldioxirane (DMD),³⁸ trifluoromethyl methyl dioxirane (TFD),³⁸ monopero-phthalic acid,⁶⁷ trifluoroperacetic acid,¹²⁸ peracetic acid,¹²⁹ hydrogen peroxide,¹³⁰ and ozone⁹³ as shown by the following representative reactions. Acyclic trisulfanes, however, are not oxidized by singlet oxygen.¹³¹ It appears that oxidative reactivity decreases with the increasing size of the sulfane chain; monosulfanes react with singlet oxygen with rate constants on the order of 10⁶ to 10⁷ M⁻¹s⁻¹ while disulfanes¹³² react with much reduced rate constants of 10⁵ M⁻¹s⁻¹. This phenomenon of decreasing reactivity with increasing sulfane chain length has been noted with other substrates¹³³ and oxidants as well. For example, only the five-membered ring and not the seven-membered ring in **13q** is oxidized with MCPBA.¹³⁴

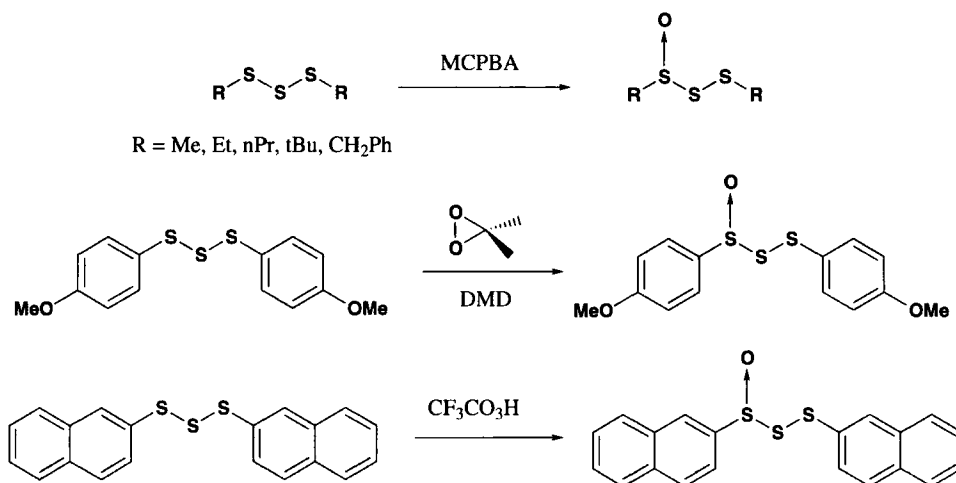

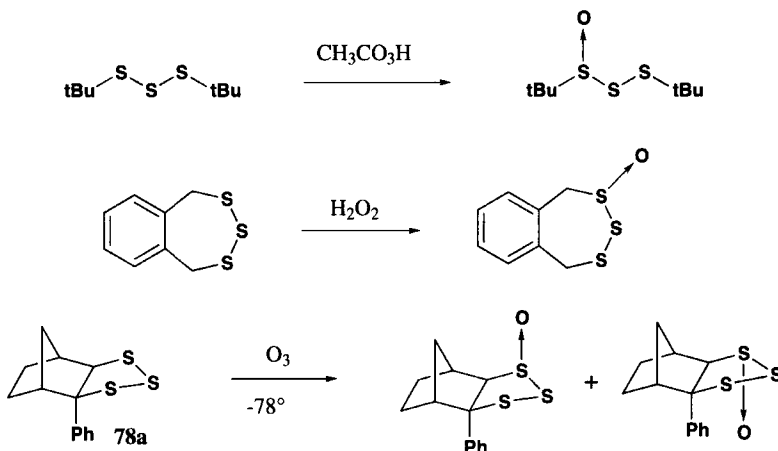

These reactions exhibit a dramatic regioselectivity for oxidation at the electron rich¹³³ terminal sulfur. Oxidation at the central sulfur is only observed in 5-membered ring trisulfanes (e. g. **13q** and **64**).⁸¹ Oxidation at the central sulfur atom of **64** occurs from the sterically less demanding endo direction to give only one, **121**, of the two possible diastereomers.⁹³ Steric shielding of the endo face with the phenyl ring in **78a** completely inhibits oxidation at the central sulfur atom. During the course of this study an unusual oxygen catalyzed epimerization of the endo-2-oxide, **121**, to the exo-2-oxide, presumably *via* the novel trioxide, **122**, was also observed.

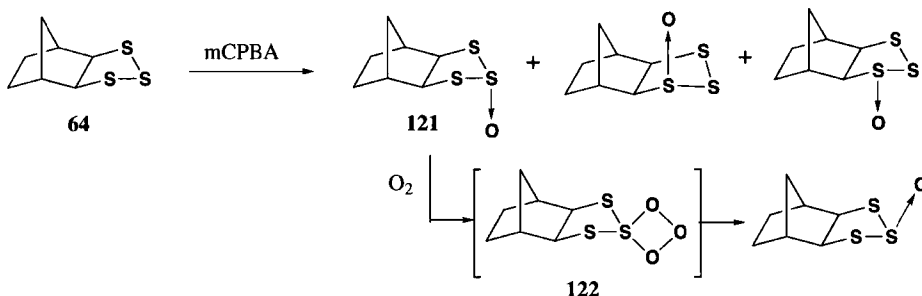

MCPBA oxidation of **13q** gave a mixture of two 2-oxides (**123** and **124**), and two 1-oxides (**125** and **126**).¹³⁴ The existence of two diastereomers for both the 1- and 2-oxides is a result of a high barrier for inversion of the petathiepin ring.¹³⁴ The activation free energies for inversion at 298 K in CHCl_3 were experimentally determined to be 23.8 ± 0.1 kcal/mol in **123**, 23.9 ± 0.1 kcal/mol in **124**, 24.0 ± 0.1 in **125**, and 24.1 kcal/mol in **126**.

Trisulfane-2-oxides are more conveniently available by the reactions of thiols with thionylchloride (SOCl_2) in the presence of a base rather than by oxidation.¹²⁴ This procedure has recently been utilized to prepare the unusually stable bis(triphenylmethyl)trisulfane-2-oxide, **9c**.¹³⁵ Unsymmetrical trisulfane-2-oxides are easily prepared using this procedure since the acid chloride, RSS(O)Cl , is a discrete intermediate formed upon addition of 1 equivalent of thiol, and can be

SYNTHESIS, PROPERTIES AND REACTIONS OF TRISULFANES AND THEIR OXIDES

prepared in situ in high yields.¹²⁴ These reaction conditions can also be utilized to prepare cyclic trisulfane-2-oxides from the sodium salts or titanocene derivatives of dithiols.

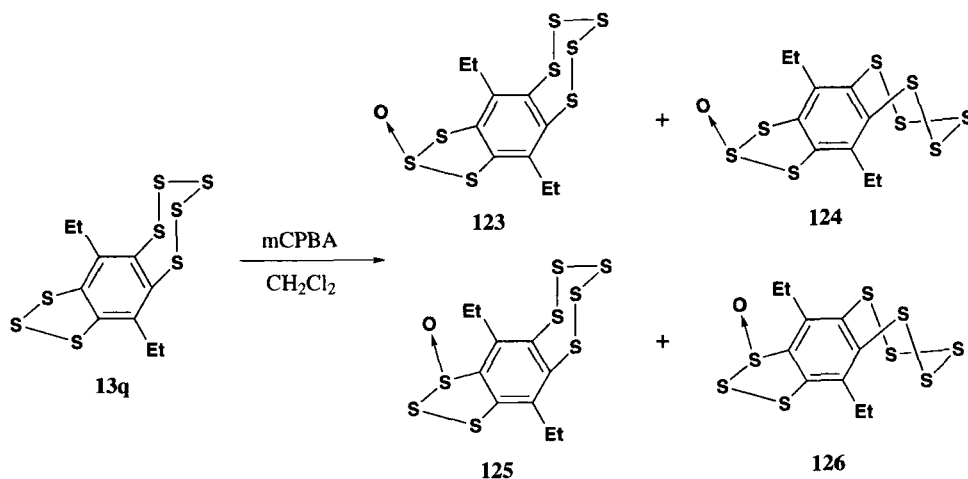

The often facile thermal decompositions of trisulfane-1-oxides have been examined with difficulty under a variety of conditions. Thermal decomposition of bis(*p*-methoxyphenyl)trisulfane-1-oxide, (**18**)-1-oxide, generated a 1:1 mixture of bis(*p*-methoxyphenyl)disulfane-1,1-dioxide and bis(*p*-methoxyphenyl)tetrasulfane while decomposition of di-*tert*-butyltrisulfane-1-oxide, (**127**), produced a more complex reaction mixture.

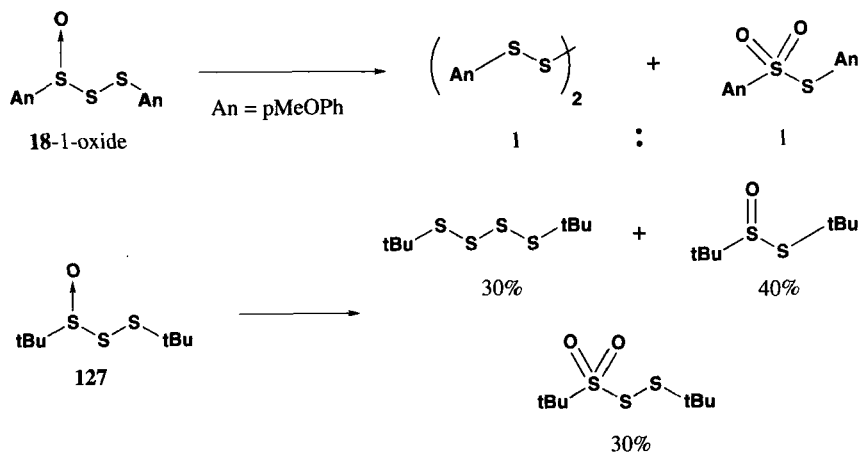

In both of these cases it has been proposed that the decomposition is initiated by heterolytic cleavage of the 1-oxide to give a sulfinyl cation and disulfane anion, and that the tetrasulfane is formed by subsequent reaction of the disulfane anion with substrate. (Fig. 13A) In the case of bis(*p*-methoxyphenyl)trisulfane-1-oxide the small size of the sulfinyl cation and anion allows dimerization to give the disulfane-1,1-dioxide. (Fig. 13B) In contrast, it has been suggested that the larger size of *tert*-butylsulfinyl cation and anion precludes dimerization, and consequently, a more complicated

reaction path is followed. (Fig. 13C) It is not immediately obvious, however, that the alternative mechanism shown in Fig. 13C is less sterically demanding than the dimerization. Perhaps the formation of the trisulfane-1,1-dioxide in the decomposition of **127** is a result of a more electrophilic sulfinyl group in **127** than in **18-1-oxide** that is better at abstracting an oxygen atom from the sulfinyl anion intermediate. Additional studies of bisaryl trisulfanes with different substituents may shed further light on these complicated reactions.

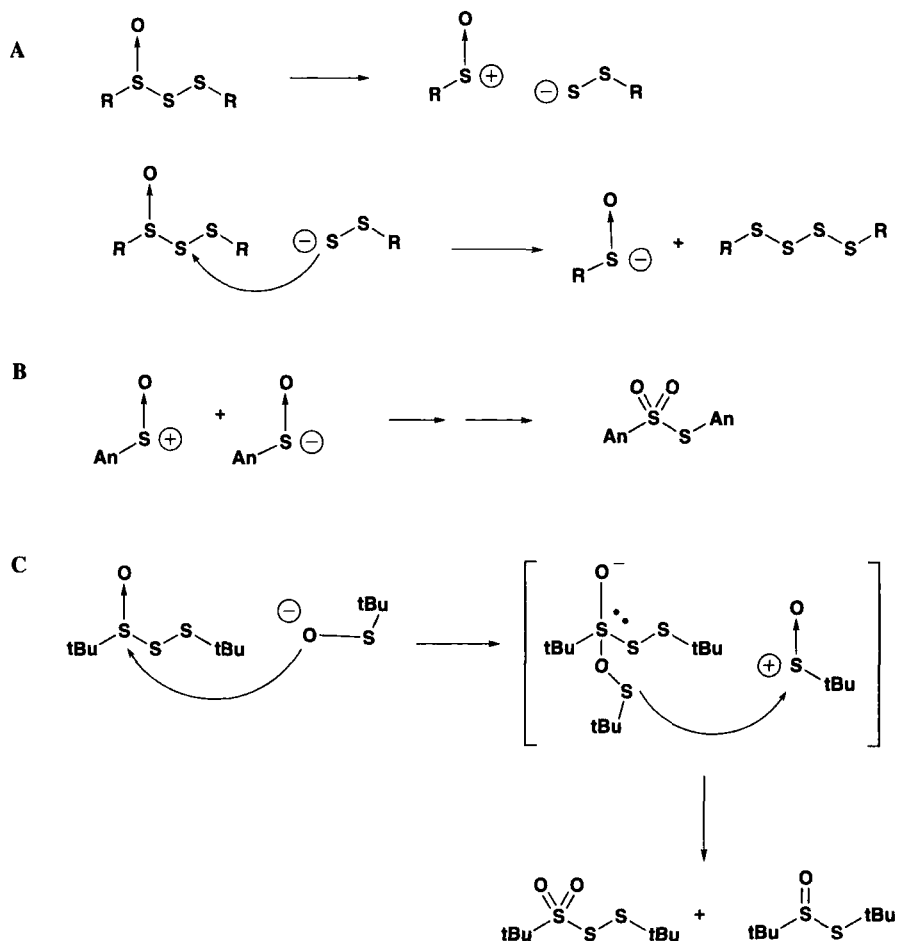

Fig. 13

The decompositions of trisulfane-2-oxides have been investigated in detail by Field and Lacey.¹²⁴ The salient experimental observations which must be explained by any successful mechanism include: (1) the stoichiometry is $2(\text{RS})_2\text{SO} \rightarrow \text{RSSR} + \text{RSSSR} + \text{SO}_2$, (2) the disappearance of the S=O IR band in trisulfane-2-oxides is first order, (3) if the R groups in the substrate, or if two different substrates are used, scrambling of groups in the products are observed, (4) thermal but not photochemical initiation of the reaction is required, (5) the reaction is catalyzed by SO_2 , and (5) tertiary alkyl

groups stabilize the trisulfane-2-oxide towards thermal decomposition more than either secondary or primary groups. A mechanism consistent with all of these observations is shown in Fig. 14.

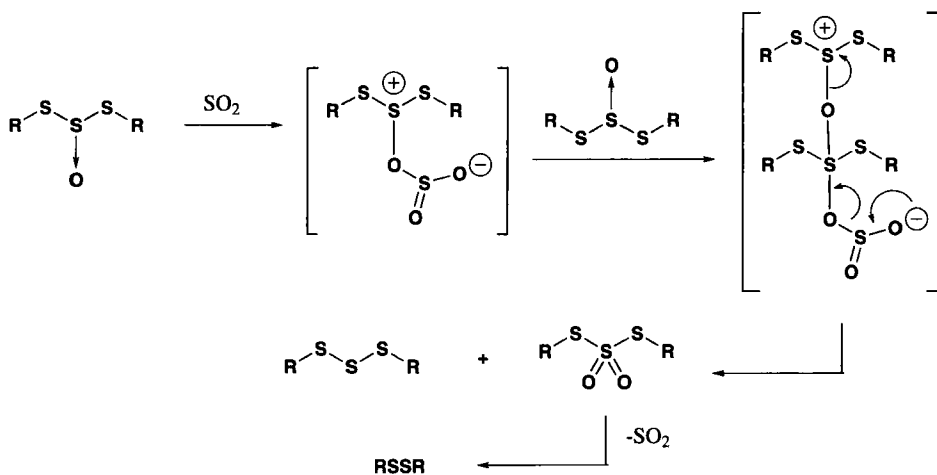
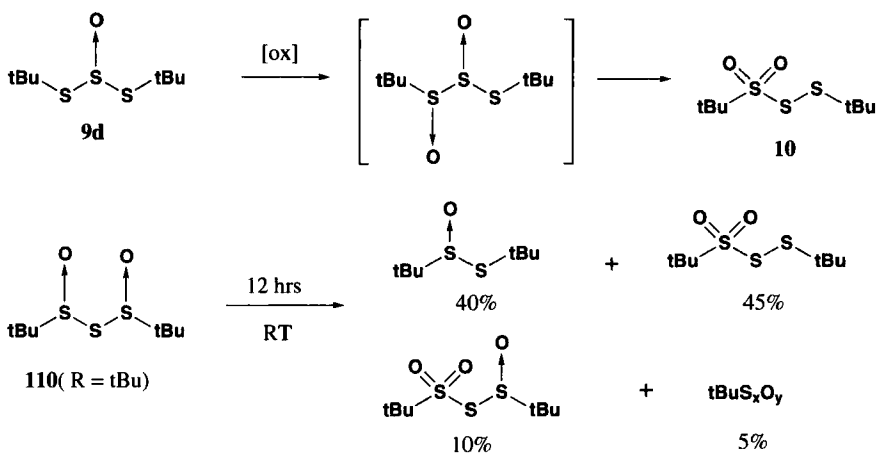

Fig. 14

b. Trisulfane-dioxides (109-112)

All four of the trisulfane-dioxides have been either observed or implicated as reactive intermediates, and they exhibit a remarkable spectrum of stability.

Trisulfane 1,1-dioxides form in both the dimethyldioxirane and MCPBA oxidations of trisulfane-1- and 2-oxides.^{5, 38, 136} For example, oxidation of di-*tert*-butyltrisulfane-2-oxide, (**9d**), with either MCPBA or dimethyldioxirane generates the trisulfane 1,1-dioxide.¹³⁶ Examination of the reaction mixture by NMR at -60° allowed spectroscopic detection of the marginally stable di-*tert*-butyltrisulfane-1,2-dioxide which is presumably a precursor of the 1,1-dioxide. Di-*tert*-butyltrisulfane-1,1-dioxide, (**10**), itself is sufficiently stable to be isolated and its X-ray structure determined.^{136, 137}



Clennan³⁸ and Freeman⁵ both reported that oxidation of a trisulfane-1-oxide generated the 1,1-dioxide. The 1,1-dioxide could presumably form in these reactions by direct oxidation at the sulfinyl sulfur, by oxidation at the central sulfur followed by rearrangement, or by oxidation at the terminal sulfenyl sulfur to form the 1,3-dioxide followed by rearrangement. Clennan³⁸ reported experimental evidence for the formation of the 1,3-dioxide which was shown to be stable under the low temperature reaction conditions. The experimental results necessary to distinguish between the other two possibilities are not available.

Trisulfane-1,1-dioxides, **111**, can be synthesized in isolable quantities by the reaction of potassium thiosulfates, **128**, with sulfenyl chlorides.¹⁰⁴ Alternatively, the reactions of hydrodisulfides with sulfonyl chlorides, **129**, have also been used to make these trisulfane oxides.¹³⁶ The stability of trisulfane-1,1-dioxides can be enhanced by electron withdrawing groups such as 2,4-dinitrophenyl- on the sulfenyl sulfur. The lifetime of these species is limited by an intermolecular sulfur expulsion reaction which generates thiosulfonate products.¹⁰⁴

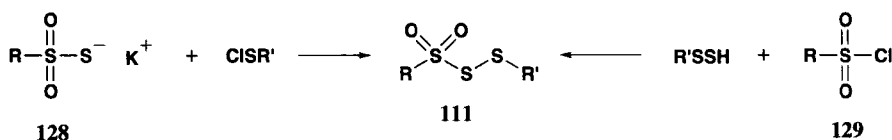

Trisulfane-1,3-dioxides, **110**, are less stable than the 1,1-dioxides, nevertheless they have been observed and spectroscopically characterized. Derbesy and Harpp¹³⁸ reported that di-*tert*-butyltrisulfane-1,3-dioxide, (**110**) (R = *t*Bu) can be isolated at room temperature and requires 12 hours to decompose. (vide supra) In addition, they report that di-*tert*-butyltrisulfane-1-oxide, (**127**), can be oxidized with several different oxidants at -40° to give only one of the two possible diastereomers. After 6 hours they report that a rearrangement occurred to give a mixture dominated by the other diastereomer. They suggest that the kinetic product is the *d,l*-diastereomer and that the thermodynamic product is the *meso* isomer. Steudel and Drozdova¹²⁶ have computationally examined the two diastereomers presumably formed in the oxidation of **127** and point out that their results do not support the results of Derbesy and Harpp.¹³⁸ The two diastereomers have very similar geometries which does not provide a justification for preferential formation of one over the other. Furthermore, the diastereomers only differ in energy by 0.4 kcal/mol precluding complete interconversion of one into the other.

Clennan and Stensaas³⁸ have suggested that a trisulfane-2,2-dioxide, **112**, is formed in the low temperature oxidation of bis(*p*-methoxyphenyl)trisulfane-2-oxide, (**18**)-2-oxide, with trifluoromethyl methyl dioxirane. The formation of bis(*p*-methoxyphenyl)trisulfane-2,2-dioxide, (**18**)-2,2-dioxide, was deduced from the formation of bis(*p*-methoxyphenyl)disulfane, (**130**), as the only product of the oxidation at -80°. It was not possible to determine if the trisulfane-2,2-dioxide was formed *via* a trisulfane-1,2-dioxide, **109**, by an established rearrangement mechanism, or by direct oxidation at the sulfinyl (SO) sulfur.

SYNTHESIS, PROPERTIES AND REACTIONS OF TRISULFANES AND THEIR OXIDES

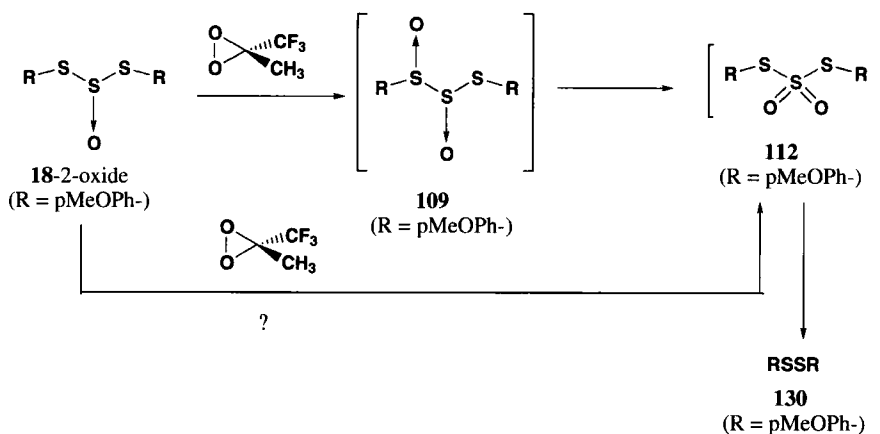

Kato, and Hashimoto⁸¹ have also suggested loss of SO₂ from a trisulfane-2,2-dioxide as a key step in the oxidative conversion of a trisulfane to brugierol, (131), and isobrugierol, 132. The reaction is suggested to involve an unusual oxidation at the central sulfur atom of the trisulfane and oxidation of the resulting disulfane (vide supra).

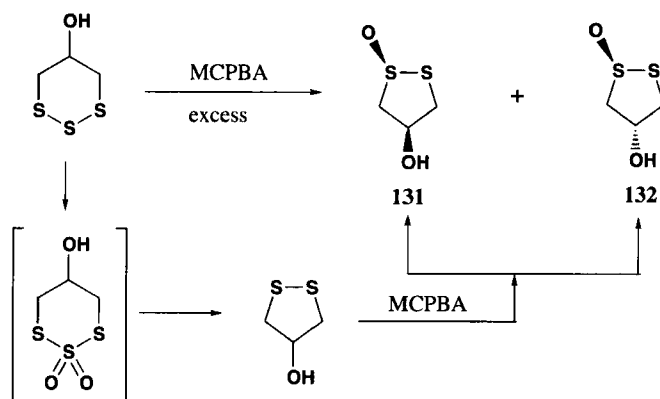

c. Trisulfane-tri- and tetraoxides (113-120).

The chemistry of the higher order trisulfane-tri- and tetraoxides is far less established than that of the lower order mono- and dioxides. Only trisulfane-1, 1,3-trioxide, 115, and trisulfane-1,1,3,3-tetraoxide, 120, are well documented materials.

Clennan and Stensaas³⁸ reported that oxidation of bis(p-methoxyphenyl)trisulfane-1-oxide with dimethyldioxirane resulted in the formation of a complex reaction mixture which included the corresponding 1,1,3-trioxide. The assignment of the 1,1,3-trioxide was based upon comparison of the methoxy chemical shifts to corresponding shifts in other oxidized derivatives.

Derbesy and Harpp¹²⁹ reported that oxidations involving di-*tert*-butyltrisulfane and several of its oxidized derivatives resulted in isolation of the trisulfane-1,1,3-trioxide, 11, which was confirmed by an X-ray structure. (Fig. 15) Examination of the oxidation of the 1,3-dioxide (C in Fig. 15) by NMR at -40° did not reveal the presence of an intermediate. This observation led to the suggestion that

oxidation occurs directly at the sulfinyl sulfur to give **11** rather than at the sulfenyl sulfur to give a 1,2,3-trioxide which rearranged to **11**. This suggestion was supported by the observation that oxidation of di-*tert*-butyltrisulfane-2-oxide with 2 equivalents of oxidizing agent did not give the 1,1, 3-trioxide.

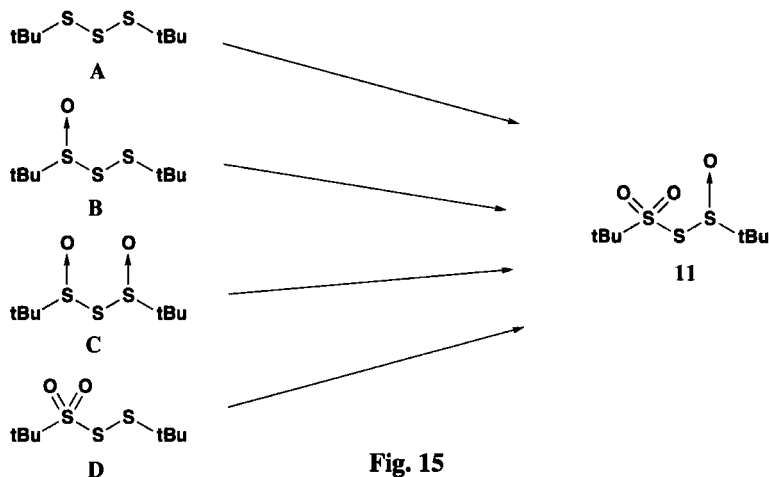
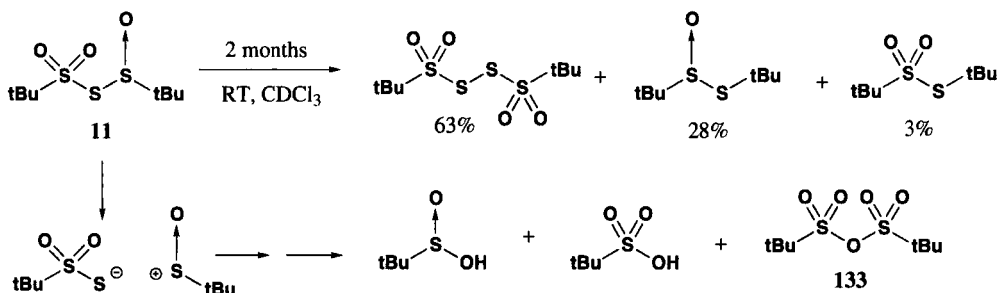

Fig. 15

The trioxide **11** is more stable than its disulfane analogue reflecting the presence of an additional sulfur atom which reduces the steric interactions between the two *tert*-butyl groups. The trioxide decomposes after approximately 2 weeks at room temperature to give a mixture consisting of 63% di-*tert*-butyltetrasulfane-1,1,4,4-tetraoxide, 28% di-*tert*-butylthiosulfinate, 3% of di-*tert*-butylthiosulfonate, and traces of di-*tert*-butyltrisulfane-1,1,3,3-tetraoxide, *tert*-butyl sulfinic acid, *tert*-butyl sulfonic acid, and the anhydride **133**. The authors suggest that the decomposition is initiated by homolytic cleavage to give *tert*-butyl sulfinyl cation and *tert*-butyl thiosulfonate anion. Reaction of the *tert*-butyl thiosulfonate anion with **11** would generate the di-*tert*-butyltetrasulfane-1,1,4,4-tetraoxide and a *tert*-butyl sulfinyl anion which can react in a complicated process similar to that described earlier (Fig. 13) to give di-*tert*-butylthiosulfonate.



Trisulfane-1,1,3,3-tetraoxide, **120**, can be synthesized by oxidation of trisulfanes, trisulfane-1,3-dioxides, or trisulfane-1,1,3-trioxides with the appropriate number of equivalents of peracids,¹³⁹ or dimethyldioxirane. Di-*tert*-butyltrisulfane-1,1,3,3-tetraoxide is sufficiently stable to allow recrystallization from *n*-pentane and structure determination by X-ray crystallography.¹²⁹

Acknowledgement. The authors thank the National Science Foundation and the donors of the Petroleum Research Fund, administered by the American Chemical Society, for their generous support of this research.

REFERENCES

1. R. Steudel, *Top. Curr. Chem.*, **102**, 149 (1982). For a more current viewpoint of the mechanistic details of reaction (1), see the section entitled *Disproportionations and Exchanges*.
2. T. L. Pickering, K. J. Saunders and A. V. Tobolsky, *J. Am. Chem. Soc.*, **89**, 2364-2 (1967).
3. M. D. Lee, T. S. Dunne, M. M. Siegel, C. C. Chang, G. O. Morton and D. B. Borders, *ibid.*, **109**, 3464 (1987).
4. M. D. Lee, T. S. Dunne, C. C. Chang, G. A. Ellestad, M. M. Siegel, G. O. Morton, W. J. McGahren and D. B. Borders, *ibid.*, **109**, 3466 (1987).
5. F. Freeman, X.-B. Ma and R. I.-S. Lin, *Sulfur Lett.*, **15**, 253 (1993).
6. C. Christophersen and U. Anthoni, *Sulfur Rep.*, **4**, 365 (1986).
7. S. J. Wratten and D. J. Faulkner, *J. Org. Chem.*, **41**, 2465 (1976).
8. R. E. Moore, *Chem. Commun.*, 1168 (1971).
9. U. Anthoni, C. Christophersen, J. Ø. Madsen, S. Wium-Andersen and N. Jacobsen, *Phytochemistry*, **19**, 1228 (1980).
10. U. Anthoni and C. Christophersen, *Tetrahedron*, **38**, 2425 (1982).
11. B. R. Copp, J. W. Blunt, M. H. G. Munro and L. K. Pannell, *Tetrahedron Lett.*, **30**, 3703 (1989).
12. M. Litaudon and M. Guyot, *ibid.*, **32**, 911 (1991).
13. R. Abdolrasulnia and J. L. Wood, *Bioorg. Chem.*, **9**, 253 (1980).
14. M. Moutiez, G. Lippens, C. Sergheraert and A. Tartar, *Bioorg. & Med. Chem. Lett.*, **7**, 719 (1997).
15. A. Schöberl and A. Wagner, in *Methoden der Organischen Chemie*, E. Müller, Eds. Stuttgart, 1955, vol. IX, pp. 87.
16. R. M. Wilson and D. N. Buchanan, in *Methodicum Chemicum. A Critical Survey of Proven Methods and Their Application in Chemistry, Natural Science and Medicine*, H. Zimmer, K. Niedenzu, Eds. (Academic Press, New York, 1978), vol. 7, pp. 585.
17. L. Field, in *Organic Chemistry of Sulfur*, S. Oae, Eds. (Plenum, New York, 1977) pp. 303.

18. K.-D. Gundermann and K. Hümke, in *Methoden der Organischen Chemie*, D. Klamann, Eds. (Thieme, Stuttgart, 1985), vol. E 11, pp. 148.
19. R. Steudel and M. Kustos, in *Encyclopedia of Inorganic Chemistry*, R. B. King, Eds. (Wiley, Chichester, 1994), vol. 7, pp. 4009.
20. **8a** G. Adwidjaja, H. Günther and J. Voss, *Angew. Chem. Int. Ed. Engl.*, **19**, 563 (1980); **8b** A. W. Mott and G. Barany, *J. Chem. Soc. Perkin Trans. 1*, 2615 (1984); **8c** I. M. Dawson and J. M. Robertson, *J. Chem. Soc.*, 1256 (1948); **8d** P. J. Cox and J. L. Wardell, *Acta Cryst. C.*, **C53**, 122 (1997). R. A. Howie and J. L. Wardell, *Acta Crystallogr., Sect. C: Cryst. Struct. Commun.*, **C52**, 1533 (1996); **8e** S. Husebye, *Acta Chem. Scand.*, **27**, 756 (1973); **8f** R. Gilardi and J. L. Flippen-Anderson, *Acta Crystallogr.*, **C41**, 72 (1985); **8g** M. Ostrowski, J. Jeske, P. G. Jones and W.-W. du Mont, *Chem. Ber.*, **126**, 1355 (1993); **8h** N. J. Brøndmo, S. Esperås, and S. Husebye, *Acta Chem. Scand. A*, **29**, 93 (1975); **8i** H. J. Berthold, *Zeit. Kristallogr.*, **116**, 290 (1961); **8j** L. F. Power and R. D. Jones, *G. Acta Crystallogr.*, **B27**, 181 (1984); **8k** C. Meyer, D. Mootz, B. Bäck and R. Minkwitz, *Z. Naturforsch.*, **52b**, 69 (1997); **8l** J. W. Bats, *Acta Crystallogr.*, **B33**, 2264 (1977); **8m** H. C. Hansen, A. Senning and R. G. Hazell, *Tetrahedron*, **41**, 5145 (1985); **8n** L. A. Chetkina, V. E. Zavodnik, V. K. Bel'skii, I. G. Aryamanova, A. P. Krysin, Y. A. Gurvich and L. I. Kuzubova, *Zh. Strukt. Khim.*, **27**, 112 (1986); **8o** A. Abu-Yousef, A. Imad and D. N. Harpp, *Tetrahedron Lett.*, **35**, 7167 (1994).
21. **9a** R. Steudel, P. Luger and H. Bradaczek, *Chem. Ber.*, **110**, 3553 (1977); **9b** C. T. Kiers and A. Vos, *Rec. Trav. Chim. Pays-Bas*, **97**, 166 (1978); **9c** M. Pridöhl, R. Steudel, J. Buschmann and P. Luger, *Z. anorg. allg. Chem.*, **621**, 1672 (1995); **9d**, **10**, **11** and **12c** G. Derbesy and D. N. Harpp, *Sulfur Rep.*, **16**, 363 (1995); **9e** W. H. Watson, M. Krawiec, T. Ghosh and P. D. Bartlett, *Acta Crystallogr.*, **C48**, 2092 (1992); **12a** A. M. Mathieson and J. M. Robertson, *J. Chem. Soc.*, 724 (1949); **12b** O. Foss, F. Kvanmen and K. Marøy, *J. Chem. Soc. Dalton Trans.*, 231-237(1985).
22. **13a** T. Sheradsky and D. Zbaida, *Heterocycles*, **20**, 1903 (1983); **13b** B. L. Chenard, R. L. Harlow, A. L. Johnson and S. A. Vladuchick, *J. Am. Chem. Soc.*, **107**, 3871 (1985); **13c** W. H. Watson, P. C. Jain, P. D. Bartlett and T. Ghosh, *Acta Crystallogr.*, **542**, 332 (1986); **13d** D. L. Coffen, D. A. Katonak, N. R. Nelson and F. D. Sancilo, *J. Org. Chem.*, **42**, 948 (1977); **13e** and **13f** B. L. Chenard, D. A. Dixon, R. L. Harlow, D. C. Roe and T. Fukunaga, *ibid.*, **52**, 2411 (1987); **13g** V. F. Lemmer, F. Fehér, A. Gieren, S. Hechtfisher and W. Hoppe, *Acta Crystallogr.*, **B29**, 2133 (1973); **13h** V. F. Fehér and B. Engelen, *ibid.*, **B35**, 1853 (1979); **13i** R. Sato, T. Kimura, T. Goto and M. Saito, *Tetrahedron Lett.*, **29**, 6291 (1988); **13j** C. P. Galloway, D. D. Doxsee, D. Fenske, T. B. Rauchfuss, S. R. Wilson and X. Yang, *Inorg. Chem.*, **33**, 4537 (1994); **13k** X. Yang, T. B. Rauchfuss and S. R. Wilson, *J. Am. Chem. Soc.*, **111**, 3465 (1989); **13l** N. Bresciani-Pahor, M. Calligaris and L. Randaccio, *Acta Crystallogr.*, **B36**, 632 (1980); **13m** M. Kustos and R. Steudel, *J. Org. Chem.*, **60**, 8056 (1995); **13n** J. Emsley, D. W. Griffiths and R. Osborn, *Acta Crystallogr.*, **B35**, 2119 (1979); **13o** A. Kato, Y. Hashimoto, I. Otsuka and K. Nakatsu, *Chem. Lett.*, 1219 (1978); **13p** and **13q** R. Sato, T. Kimura, T. Goto, M. Saito and C. Kabuto, *Tetrahedron Lett.*, **30**, 3453 (1989); **13r** D. A. Nugiel and M. M. Abelman, *J. Org. Chem.*, **60**, 3554 (1995); **13s** In the April 1997 release of the Cambridge Structural Database F. H. Allen and O. Kennard, *Chemical Design Automation News*, **8**, 31 (1993); **13t** T. S. Cameron, R. C. Haddon, S. M. Mattar, S. Parsons, J. Passmore and A. P. Ramirez, *Chem. Commun.*, 358 (1991).

23. **14a** I. R. Butler, W. R. Cullen, F. G. Herring, N. R. Jagannathan, F. W. B. Einstein and R. Jones, *Inorg. Chem.*, **25**, 4534 (1986); **14b** S. L. Ingham and N. J. Long, *Angew. Chemie Int. Ed. Engl.*, **33**, 1752 (1994); **14c** M. Herberhold, H.-D. Brendel and U. Thewalt, *Angew. Chem. Int. Ed. Engl.*, **30**, 1652 (1991); **14d** E. W. Abel, N. J. Long, A. G. Osborne, M. B. Hursthouse and M. A. Mazid, *J. Organomet. Chem.*, **430**, 117 (1992); **14e** S. Jeannin, Y. Jeannin and G. Lavigne, *Inorg. Chem.*, **18**, 3528 (1979); **14f** B. R. Davis and I. Bernal, *J. Cryst. Mol. Struct.*, **2**, 143 (1972); **14g** N. J. Long, S. J. Sharkey, M. B. Hursthouse and M. A. Mazid, *J. Chem. Soc. Dalton Trans.*, 23 (1993); **14h** D. L. Compton and T. B. Rauchfuss, *Organomet.*, **13**, 4367 (1994); **14i** N. J. Long, P. R. Raithby and P. Zanello, *J. Chem. Soc. Dalton Trans.*, 1245 (1995).
24. **15a** M. Yokoyama, T. Shiraishi, H. Hatanaka and K. Ogata, *Chem. Commun.*, 1704 (1985); **15b** K.-W. Wei, I. C. Paul, R. J. S. Beer and A. Naylor, *ibid.*, 264 (1975); **15c** Y. Wang, M. J. Chen and C. H. Wu, *Acta Crystallogr.*, **B44**, 179 (1988); **15d** Y. Wang, S. Y. Wu and A. C. Cheng, *ibid.*, **B46**, 850 (1990); **15e** L. K. Hansen and A. Hordvik, *Acta Chem. Scand.*, **27**, 411 (1973); **15f** P. L. Johnson, E. C. Liaguno and I. C. Paul, *J. Chem. Soc. Perkin Trans. I*, 234 (1976); **15g** E. C. Liaguno, C. T. Mabani and I. C. Paul, *ibid.*, 239 (1976); **15h** S. M. Johnson, M. G. Newton and I. C. Paul, *J. Chem. Soc. B*, 986 (1969); **15i** R. Minkwitz, V. Gerhard, R. Krause, H. Prenzel and H. Preut, *Z. Anorg. Allg. Chem.*, **559**, 154 (1988) and R. Minkwitz, R. Krause and H. Preut, *ibid.*, **571**, 133 (1989); **15j** R. Minkwitz, R. Krause and H. Goesmann, *ibid.*, **591**, 150 (1990).
25. J. W. Bats, *Acta Crystallogr.* **B33**, 2264 (1977).
26. N. J. Brøndmo, S. Esperås and S. Husebye, *Acta Chem. Scand.*, **A 29**, 93 (1975).
27. F. H. Allen and O. Kennard, *Chemical Design Automation News*, **8**, 31 (1993).
28. P. L. Johnson, E. C. Liaguno and I. C. Paul, *J. Chem. Soc. Perkin Trans. I*, 234 (1976).
29. Y. Wang, M. J. Chen and C. H. Wu, *Acta Crystallogr.*, **B44**, 179 (1988).
30. Y. Wang, S. Y. Wu and A. C. Cheng, *ibid.*, **B46**, 850 (1990).
31. Y. Wang, S. K. Yeh, S. Y. Wu, C. T. Pai, C. R. Lee and K. J. Lin, *Acta Crystallogr.*, **B47**, 298 (1991).
32. J. P. Snyder and D. N. Harpp, *Tetrahedron Lett.*, 197 (1978).
33. I. R. Butler, W. R. Cullen, F. G. Herring, N. R. Jagannathan, F. W. B. Einstein and R. Jones, *Inorg. Chem.*, **25**, 4534 (1986).
34. N. J. Long, S. J. Sharkey, M. B. Hursthouse and M. A. Mazid, *J. Chem. Soc. Dalton Trans.*, 23 (1993).
35. E. W. Abel, N. J. Long, K. G. Orrell, A. G. Osborne and V. Sik, *J. Organomet. Chem.*, **419**, 375 (1991).
36. E. Block, M. D. Bentley, F. A. Davis, I. B. Douglass and J. A. Lacadie, *J. Org. Chem.*, **40**, 2770

- (1975).
37. V. S. Shmakov, I. I. Furley, A. D. Ulendeeva and N. K. Lyapina, *Russ. Chem. Bull.*, **46**, 1472 (1997).
38. E. L. Clennan and K. L. Stensaas, *J. Org. Chem.*, **61**, 7911 (1996).
39. D. L. J. Clive, Y. Bo, V. Tao, S. Daigneault, Y.-J. Wu and G. Meignan, *J. Am. Chem. Soc.*, **118**, 4904 (1996).
40. D. A. Nugiel and M. M. Abelman, *J. Org. Chem.*, **60**, 3554 (1995).
41. G. Barany and A. W. Mott, *ibid.*, **49**, 1043 (1984).
42. D. N. Harpp and R. A. Smith, *ibid.*, **44**, 4140 (1979).
43. R. Steudel, M. Kustos, M. Pridöhl and U. Westphal, *Phosphorus, Sulfur and Silicon*, **93-94**, 61 (1994).
44. E. W. Abel and D. A. Armitage, *J. Chem. Soc.*, 5975 (1964).
45. J. L. Wardell and P. L. Clarke, *J. Organomet. Chem.*, **26**, 345-352 (1971).
46. N. Yamazaki, S. Nakahama, K. Yamaguchi and T. Yamaguchi, *Chem. Lett.*, 1355 (1980).
47. G. Derbesy and D. N. Harpp, *Tetrahedron Lett.*, **35**, 5381 (1994).
48. P. W. Ford and B. S. Davidson, *J. Org. Chem.*, **58**, 4522 (1993).
49. G. Goor, M. and Anteunis, *Synthesis*, 329 (1975).
50. Q. E. Thompson, *J. Org. Chem.*, **30**, 2703 (1965).
51. D. N. Harpp, K. Steliou and T. H. Chan, *J. Am. Chem. Soc.*, **100**, 1222 (1978).
52. D. N. Harpp and T. G. Back, *Tetrahedron Lett.*, 1481 (1972).
53. G. Büchi and R. M. Freidinger, *J. Am. Chem. Soc.*, **96**, 3332 (1974).
54. A. Banerji and G. P. Kalena, *Tetrahedron Lett.*, **21**, 3003 (1980).
55. A. B. Sullivan and K. Boustany, *Int. J. Sulfur Chem., A* **1**, 207 (1971).
56. P. Magnus, R. Lewis and F. Bennett, *J. Am. Chem. Soc.*, **114**, 2560 (1992).
57. A. W. Mott and G. Barany, *Synthesis*, 657 (1984).
58. S. Munavalli, D. I. Rossman, D. K. Rohrbaugh, C. P. Ferguson and F.-L. Hsu, *Heteroatom*

- Chem.*, **3**, 189 (1992).
59. H. Kagami and S. Motoki, *J. Org. Chem.*, **42**, 4139 (1977).
60. S. Kawamura, T. Horii and J. Tsurugi, *ibid.*, **36**, 3677 (1971).
61. D. N. Harpp, D. K. Ash, T. G. Back, J. G. Gleason, B. A. Orwig, W. F. Van Horn and J. P. Snyder, *Tetrahedron Lett.*, 3551 (1970).
62. G. Derbersy, D. N. Harpp, B. Rather and G. Carroll, *Sulfur Lett.*, **14**, 199 (1992).
63. S. Munavalli, A. J. Muller, D. I. Rossman, D. K. Rohrbaugh and C. P. Ferguson, *J. Fluorine Chem.*, **67**, 37 (1994).
64. R. Chandra and L. Field, *J. Org. Chem.*, **51**, 1844 (1986).
65. L. Field and J. D. Buckman, *ibid.*, **33**, 3865 (1968).
66. G. T. Bowman and L. Field, *ibid.*, **47**, 222 (1982).
67. B. Milligan and J. M. Swan, *J. Chem. Soc.*, 2901 (1965).
68. D. N. Harpp and A. Granata, *Tetrahedron Lett.*, 3001 (1976).
69. D. N. Harpp and A. Granata, *J. Org. Chem.*, **44**, 4144 (1979).
70. G. Capozzi, A. Capperucci, A. Degl'Innocenti, R. Del Duce and S. Menichetti, *Gazz. Chim. Ital.*, **120**, 421 (1990).
71. C. Leriverend and P. Metzner, *Tetrahedron Lett.*, **35**, 5229 (1994).
72. G. Le Guillanton, Q. T. Do, D. Elothmani and J. Simonet, *Phosphorus, Sulfur and Silicon*, **74**, 375 (1993).
73. G. Le Guillanton, D. Q. Tho and J. Simonet, in *Chem. Abstract Vol. 118 #168808*. France, (1993), pp. 21 pages.
74. B. Parmentier, M. Moutiez, A. Tartar and C. Sergheraert, *Tetrahedron Lett.*, **35**, 3531 (1994).
75. See citation for **13b** in reference 22.
76. R. Sato, T. Kimura, T. Goto and M. Saito, *ibid.*, **29**, 6291 (1988).
77. C. R. Williams, J. F. Britten and D. N. Harpp, *J. Org. Chem.*, **59**, 806 (1994).
78. E. Block, R. DeOrazio and M. Thiruvazhi, *ibid.*, **59**, 2273 (1994).
79. F. Fehér, G. Krause and K. Vogelbruch, *Chem. Ber.*, **90**, 1570 (1957).

80. G. Morel, E. Marchand and A. Foucaud, *Synthesis*, 918 (1980).
81. For a reported exception to this statement see: A. Kato and Y. Hashimoto, in *Natural Sulfur Compounds: Novel Biochemical and Structural Aspects*, D. Cavallini, G. E. Gaull, V. Zappia, Eds. (Plenum, New York, 1980) pp. 361.
82. R. Sato, T. Kimura, T. Goto, M. Saito and C. Kabuto, *Tetrahedron Lett.*, **30**, 3453 (1989).
83. M. G. Voronkov, N. S. Vyazankin, E. N. Deryagina and V. A. Usov, *Reaction of Sulfur with Organic Compounds.*, J. S. Pizey, Eds., Consultants Bureau, New York and London, (1987).
84. C. G. Krespan and W. R. Brasen, *J. Org. Chem.*, **27**, 3995 (1962).
85. A. Z. Rys and D. N. Harpp, *Tetrahedron Lett.*, **38**, 4931 (1997).
86. H. Fritz and C. D. Weis, *ibid.*, 1659 (1974).
87. P. D. Bartlett and T. Ghosh, *J. Org. Chem.*, **52**, 4937 (1987).
88. H. G. Heal and J. Kane, in *Inorganic Syntheses* W. L. Jolly, Eds. (McGraw Hill Book Company, New York, 1968), vol. 11, pp. 184.
89. H. G. Heal, in *Inorganic Sulphur Chemistry*, G. Nickless, Eds. Elsevier Publishing Company, New York, (1968) pp. 459.
90. S. Inoue, T. Tezuka, S. Oae, *Phosphorus and Sulfur* **4**, 219 (1978).
91. J. A. Elvidge, S. P. Jones and T. L. Peppard, *J. Chem. Soc. Perkin Trans. I*, 1089 (1982).
92. K. Steliou, *Acc. Chem. Res.*, **24**, 341 (1991).
93. T. Ghosh and P. D. Bartlett, *J. Am. Chem. Soc.*, **110**, 7499 (1988).
94. K. Steliou, Y. Gareau and D. N. Harpp, *ibid.*, **106**, 799 (1984).
95. R. F. English, O. A. Rakitin, C. W. Rees and O. G. Vlasova, *J. Chem. Soc. Perkin Trans. I*, 201 (1997).
96. R. Sato, S. Satoh and M. Saito, *Chem. Lett.*, 139 (1990).
97. T. L. Gilchrist and J. E. Wood, *Chem. Commun.*, 1460 (1992).
98. S. L. Tardif, C. R. Williams and D. N. Harpp, *J. Am. Chem. Soc.*, **117**, 9067 (1995).
99. K. Steliou, Y. Gareau, G. Milot and P. Salama, *J. Am. Chem. Soc.*, **112**, 7819 (1990).
100. A. S. Micallef and S. E. Bottle, *Tetrahedron Lett.*, **38**, 2303 (1997).

SYNTHESIS, PROPERTIES AND REACTIONS OF TRISULFANES AND THEIR OXIDES

101. C. D. Trivette Jr. and A. Y. Coran, *J. Org. Chem.*, **31**, 100 (1966).
102. P. Magnus, R. T. Lewis and F. Bennett, *Chem. Commun.*, 916 (1989).
103. D. N. Harpp, R. A. Smith and K. Steliou, *J. Org. Chem.*, **46**, 2072 (1981).
104. D. N. Harpp, D. K. Ash and R. A. Smith, *ibid.*, **44**, 4135 (1979).
105. D. N. Harpp, in *Perspectives in the Organic Chemistry of Sulfur*, B. Zwanenburg, A. J. H. Klunder, Eds. Elsevier, Amsterdam, (1987) pp. 1.
106. D. Barnard, T. H. Houseman, M. Porter and B. K. Todd, *Chem. Commun.*, 371 (1969).
107. N. Yomoji, S. Satoh, S. Ogawa and R. Sato, *Tetrahedron Lett.*, **34**, 673 (1993).
108. N. Yomoji, S. Takahashi, S. Chida, S. Ogawa and R. Sato, *J. Chem. Soc. Perkin Trans. 1*, 1995 (1993).
109. L. P. Turchaninova, E. N. Sukhomazova, N. A. Korchevin, E. N. Deryagina and M. G. Voronkov, *Zh. Org. Khim.*, **28**, 537 (1992).
110. E. N. Sukhomazova, L. P. Turchaninova, N. A. Korcherin, E. N. Deryagina and M. G. Voronkov, *J. Org. Chem. USSR*, **26**, 1059 (1990).
111. M. G. Voronkov, É. N. Deryagina, L. A. Ostroukhova, N. A. Korchevin, É. N. Sukhomazov, A. R. Zhnikin and L. P. Turchaninova, *ibid.*, **25**, 2320 (1989).
112. R. E. Davis, in *Survey of Progress in Chemistry A.*, F. Scott, Eds. Academic Press, New York, (1964), vol. 2, pp. 189.
113. R. Sato, T. Sato, Y. Takikawa and S. Takizawa, *Tech. Rep. Iwate Univ.*, **13**, 37 (1979).
114. D. N. Harpp, D. K. Ash and R. A. Smith, *J. Org. Chem.*, **45**, 5155 (1980).
115. D. N. Harpp and R. A. Smith, *J. Am. Chem. Soc.*, **104**, 6045 (1982).
116. E. L. Clennan and P. C. Heah, *J. Org. Chem.*, **49**, 2284 (1984).
117. C. J. Li and D. N. Harpp, *Tetrahedron Lett.*, **34**, 903 (1993).
118. D. C. Mulhearn and S. M. Bachrach, *J. Am. Chem. Soc.*, **118**, 9415 (1996).
119. A. G. Myers, S. B. Cohen and B. M. Kwon, *ibid.* **116**, 1255 (1994).
120. S. Munavalli, D. I. Rossman, D. K. Rohrbaugh, C. P. Ferguson and H. D. Banks, *J. Fluorine Chem.*, **60**, 85 (1993).
121. S. Munavalli, D. I. Rossman, D. K. Rohrbaugh, C. P. Ferguson and L. J. Szafraniec, *ibid.*, **59**, 91

- (1992).
122. C. R. Williams and D. N. Harpp, *Sulfur Lett.*, **16**, 63 (1993).
123. R. Steudel, *Phosphorus Sulfur*, **23**, 33 (1985).
124. L. Field and W. B. Lacefield, *J. Org. Chem.* **31**, 3555 (1966).
125. G. Derbesy and D. N. Harpp, *J. Org. Chem.*, **60**, 4468 (1995).
126. R. Steudel and Y. Drozdova, *Chem. Eur., J.* **2**, 108 (1996).
127. J. Auger, Y. Koussourakos and E. Thibout, *Chimida Chronika, New Series*, **14**, 263 (1985).
128. R. Steudel and J. Latte, *Chem. Ber.*, **110**, 423 (1977).
129. G. Derbesy and D. N. Harpp, *J. Org. Chem.*, **61**, 9471 (1996).
130. P. K. Singh, L. Field and B. J. Sweetman, *J. Org. Chem.*, **53**, 2608 (1988).
131. E. L. Clennan, K. Stensaas, Unpublished results.
132. E. L. Clennan, D. Wang, C. Clifton and M.-F. Chen, *J. Am. Chem. Soc.*, **119**, 9081 (1997).
133. G. Derbesy and D. N. Harpp, *Sulfur Lett.* **19**, 1 (1995).
134. T. Kimura, M. Hanzawa, E. Horn, Y. Kawai, S. Ogawa and R. Sato, *Tetrahedron Lett.* **38**, 1607 (1997). For another example of stereoisomerism based on the high barrier of inversion see: Y. Sugihara, H. Takeda and J. Nakayama, *ibid.*, **39**, 2605-2608 (1998).
135. M. Pridöhl, R. Steudel, J. Buschmann and P. Luger, *Z. Anorg. Allg. Chem.*, **621**, 1672 (1995).
136. G. Derbesy and D. N. Harpp, *J. Org. Chem.*, **61**, 991 (1996).
137. G. Derbesy and D. N. Harpp, *Sulfur Rep.*, **16**, 363 (1995).
138. G. Derbesy and D. N. Harpp, *Sulfur Lett.*, **18**, 167 (1995).
139. V. F. Fehér, K.-H. Schäfer and W. Becher, *Z. Naturforsch.*, **17b**, 847 (1962).

(Received May 26, 1998; in final form September 21, 1998)